

# 2-way ball valve Stainless Steel

# MKHP420

Two-way

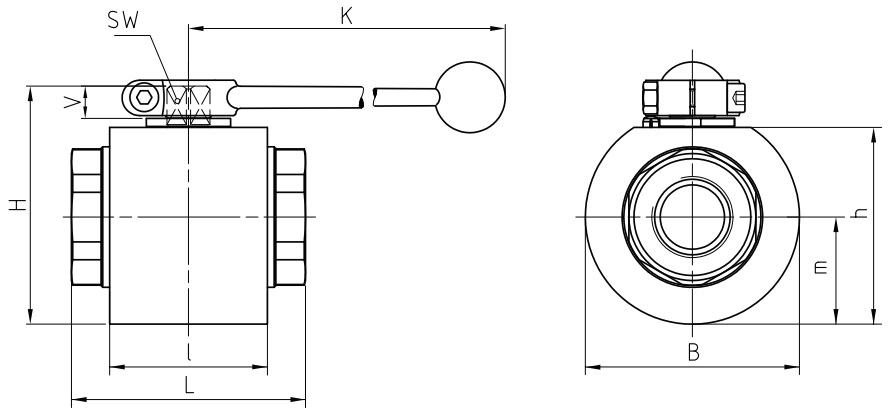
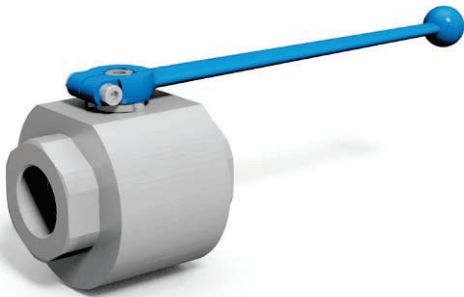

## AVAILABLE SIZES

DN32 - DN50 (1 1/4" to 2")

## CONNECTIONS

DIN ISO 228 Female thread, ANSI B1.20.1 NPT Female thread, DIN 2353/ISO 8434-1 Light / Heavy series, SAE J 514/ISO/DIS11926-1 Female thread, others on request

## ACCESSORIES ON REQUEST

- Locking devices page 222 - 225
- Actuators 220 - 221
- Mounting holes 28
- Position switches 228 - 229
- Combinations on request
- Detent on request

## MATERIAL CODE DESCRIPTION

Materials	442A	4428
Body	Stainless Steel	Stainless Steel
Ball	Stainless Steel	Stainless Steel
Stem	Stainless Steel	Stainless Steel
Ball seats	POM	POM
O-rings	NBR	FPM
Tmin / Tmax	-30°C / 100°C	-20°C / 100°C

## GENERAL DIMENSIONS

Type	l	B	H	h	m	V	SW	K	Lever
MKHP420-DN32	80	109	121	100	54,5	16,5	17	320	Al
MKHP420-DN40	85	124	136	115	62	16,5	17	320	Al
MKHP420-DN50	101	132	145	124	66	16,5	17	320	Al

# 2-way ball valve Stainless Steel

## MKHP420

Two-way

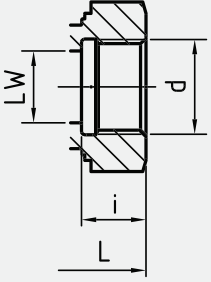
CONNECTION TYPE	DIMENSIONS						ORDER CODE PER MATERIAL COMBINATION		
DIN ISO 228 FEMALE THREAD	Type	LW	L	i	d	Weight [Kg]	PN [bar]	442A	4428
	MKHP420-DN32-G1 1/4	32	111	22	G1 1/4	5,67	420	50006*	49265*
	MKHP420-DN40-G1 1/2	38	130	24	G1 1/2	8,16	420	49271*	49102*
	MKHP420-DN50-G2	48	140	26	G2	10,45	420	49764*	51637*

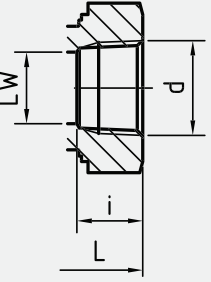
ANSI B1.20.1 NPT FEMALE THREAD	Type	LW	L	i	d	Weight [Kg]	PN [bar]	442A	4428
	MKHP420-DN32-1 1/4"NPT	32	120	22,1	1 1/4"NPT	5,72	420	48751*	53257*
	MKHP420-DN40-1 1/2"NPT	38	130	22,1	1 1/2"NPT	8,16	420	53256*	53258*
	MKHP420-DN50-2"NPT	48	140	30,3	2"NPT	10,37	420	51994*	53259*

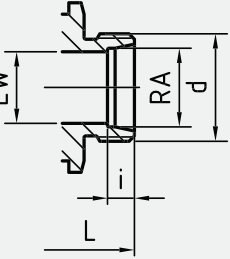
DIN 2353 / ISO 8434-1 LIGHT SERIES	Type	LW	RA	L	i	d	Weight [Kg]	PN [bar]	442A	4428
	MKHP420-DN32-35L	32	35	136	10,5	M 45x2	5,78	420	53260*	53261*
	MKHP420-DN40-42L	38	42	147	11	M 52x2	8,35	420	48766*	49335*

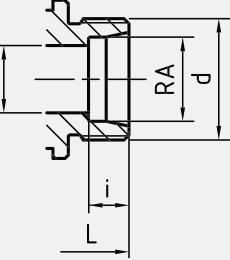
DIN 2353 / ISO 8434-1 HEAVY SERIES	Type	LW	RA	L	i	d	Weight [Kg]	PN [bar]	442A	4428
	MKHP420-DN32-38S	32	38	148	16	M 52x2	5,97	420	51699*	53262*

# 2-way ball valve Stainless Steel

## MKHP420

Two-way

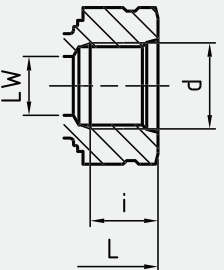
CONNECTION TYPE	DIMENSIONS						ORDER CODE PER MATERIAL COMBINATION		
SAE J514/ISO/DIS11926-1 FEMALE THREAD	Type	LW	L	i	d	Weight [Kg]	PN [bar]	442A	4428
	MKHP420-DN32-1 5/8" UN	30	111	20	1 5/8"-12 UN	5,72	420	37187*	53263*
	MKHP420-DN40-1 7/8" UN	38	130	20	1 7/8"-12 UN	8,16	420	37188*	37191*
	MKHP420-DN50-2 1/2" UN	45	140	20	2 1/2"-12 UN	9,47	420	53264*	37192*

Please note the pressure ratings of the tube connections!

\*Article usually in stock.

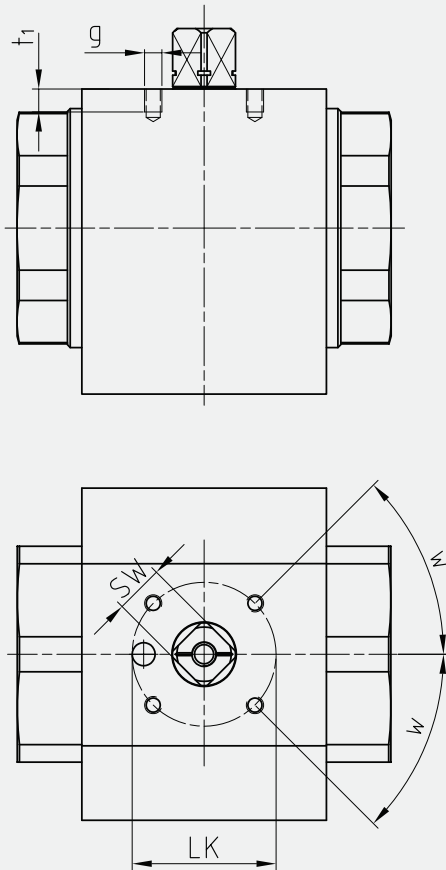

### ASSEMBLING THREADS AS PER ISO 5211

DN	SW	LK	g	t <sub>1</sub>	w	ISO5211
32	17	50	M6	8	45°	F05
40	17	50	M6	8	45°	F05
50	17	50	M6	8	45°	F05