

GENERAL DESCRIPTION



- Revo M has been specifically designed to be an Universal Unit
- RS485 Comm. MODBUS Protocol Standard
- Frontal Key Pad to configure the unit and to read V, I and Power
- Configurability via RS485, USB Port and frontal Key Pad
- Microprocessor based electronic circuit fully isolated from power
- Universal input signal: RS485, Pot, Analog and SSR
- Firing Mode: Zero Crossing and Burst Firing Mode with programmable cycle time
- Configurable Control Mode: V and VxI
- Heater Break alarm to diagnose partial or total load failure and Thyristor Short circuit
- Digital input configurable
- Fuse and Fuse Holder Standard
- Current transformer integrated in Fuse Holder
- Comply with EMC, cUL pending
- IP20 Protection
- Panel mounting

TECHNICAL SPECIFICATION

Voltage power supply	From 24V to 480V Max (Std) or 600V on request		
Voltage Frequency	50 or 60 Hz no setting needed from 47 to 70 Hz		
Nominal Current	30A, 35A, 40A		
Input Signal	SSR (logic)	4:30Vdc	5mA Max (On > 4Vdc Off ≤ 1Vdc);
	Voltage input	0:10Vdc	impedance 15 K ohm;
	Current input	0:20/4:20mA	impedance 100 Ohm;
Digital input	4:30V dc 5 mA Max (On > 4Vdc Off < 1Vdc)		
Firing	Burst Firing and Zero Crossing with possibility to set number of Burst and cycle time		
Control Mode	Voltage Current and Power selectable via frontal Key Pad, and RS485 or via Digital input to transfer from one control mode to another one to establish a control strategy.		
Auxiliary Voltage Supply	90:130Vac	8VA Max	
	170:265Vac	8VA Max	(Standard)
	230:345Vac	8VA Max	
	300:530Vac	8VA Max	(Standard)
	510:690Vac	8VA Max	
Heater Break Alarm	HB alarm setting on front unit or RS485 with possibility to set sensitivity. Relay output 0,5A at 110V		
Mounting	DIN RAIL Mounting or Panel Mounting		
Operating Temperature	40 °C without derating. Over this temperature see below derating curve		
Storage temperature	-25 °C to 70 °C Max		
Altitude	Over 1000 m of altitude reduce the nominal current of 2% for each 100m		
Humidity	From 5 to 95% without condense and ice		

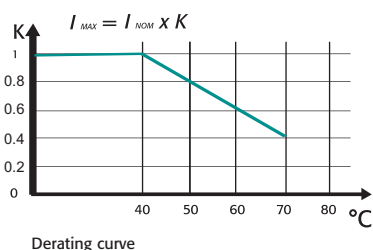

OPTION'S FEATURES AND SPECIAL DETAILS

HEATER BREAK ALARM HB

ON FRONT CABINET

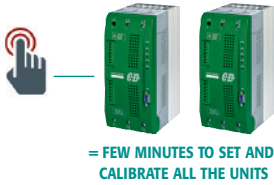

The Heater Break circuit diagnostic partial or total load failure. It reads load resistance with an internal voltage transducer and current transformer to calculate the resistance value V/I .

The Heater Break circuit is compensated for voltage fluctuation, in fact a voltage variation has no influence on resistance value because V/I ratio remain constant.

On this unit is possible to set the nominal resistance value and the alarm sensitivity.

HB alarm in addition diagnostic the thyristor in short circuit

A normally open contact gives the alarm condition and an indication of the alarm type appears on display.

BURST FIRING BF

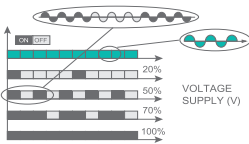

This firing is performed digitally within the thyristor unit at zero volts, producing no EMC interference. Analogue input is necessary for BF and the number of complete cycles must be specified for 50% power demand. This value can be between 1 and 255 complete cycles, determining the speed of firing. When 1 is specified, the firing mode becomes Single Cycle (SC).

FIELD BUS MODULE



CD-RS Used to convert RS232 to RS422

TU-RS485-PDP Used to convert RS485 Modbus to Profibus DP

TU-RS485-ETH Used to convert RS485 Modbus to Ethernet

For more informations see "Field Bus Module" Bulletin

POWER SCALING

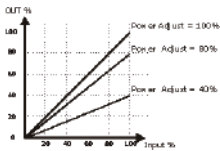

It's a scaling factor of the input command signal and limit the output of Thyristor unit. This parameter can be adjusted from 1 to 99% via RS485 or by the front of the unit. If this parameter is set at 50% and the input signal is 100% the output become 50%. This feature is very useful to reduce the power when a zone has been oversized or when a temperature controller gives same reference to more unit along a furnace.

Imagine 3 zones with left and right one close to the door where in a continuous furnace the material come into and flow out. The profile of temperature along furnace is higher in central zone because there is less dispersion but if we scale its input we can have a flat profile.

APPLICATIONS AND FOCUS ON:

- Infrared lamp.
- Fournaces.
- Petrochemical
- Dryers
- Pharmaceutical
- Autoclaves.
- Chemical
- Extrusion line.
- Climatic chambers

WIRING CONNECTION REVO M 3PH from 30A to 40A

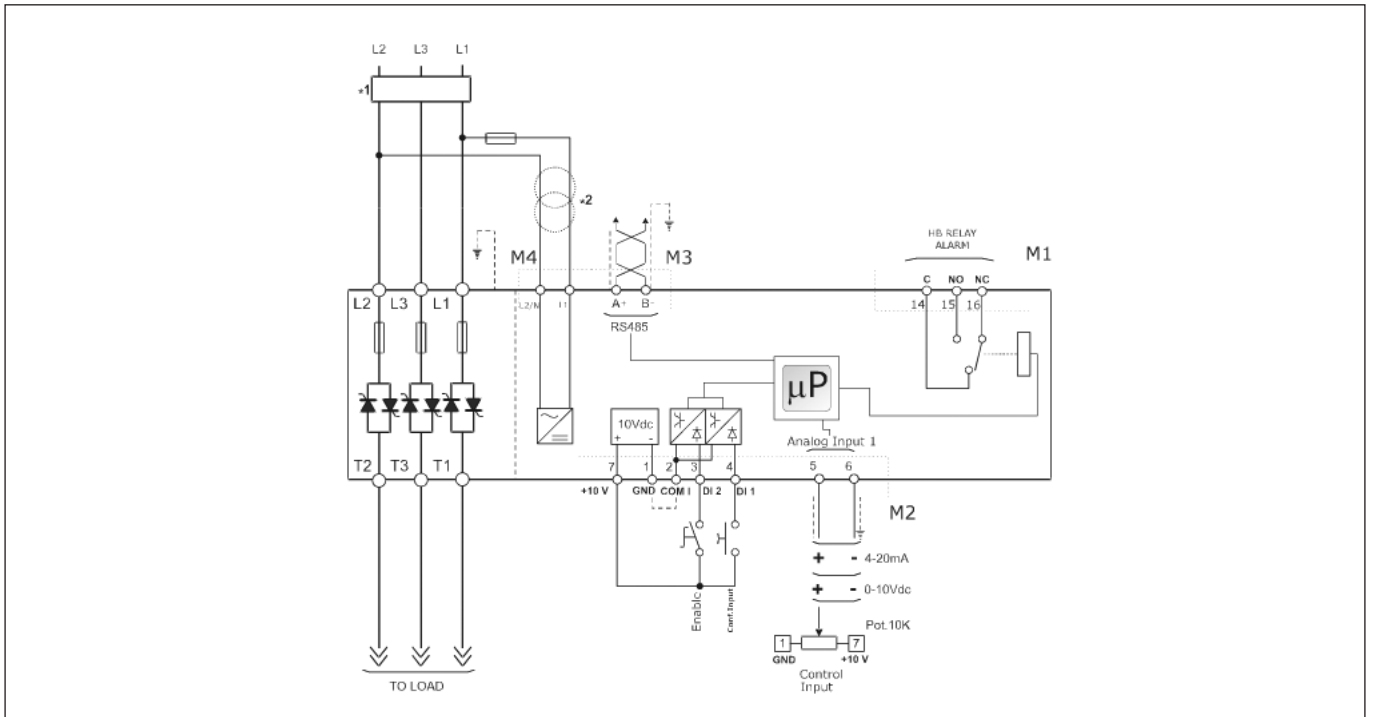

LOAD TYPE

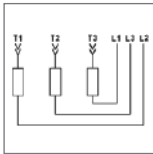

OPEN DELTA
Resistive or
Infrared Lamps
Long and
medium waves

LOAD TYPE

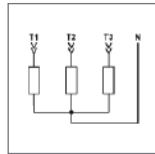

STAR with neutral
Resistive or
Infrared Lamps
Long and
medium waves

NOTE

- The user installation must be protected by electromagnetic circuit breaker or by fuse isolator. The Fuse I_{2t} should be 20% less than I_{2t} of power controller. Semiconductor fuses are classified for UL as supplementar protection for semiconductor. They are note approved for branch circuit protection.
- The auxiliary voltage supply of the Revo M unit must be synchronized with loadvoltage power supply. If the Auxiliary Voltage (written on the identification label) is different from Supply Voltage (to the load), use an external transformer as designated.

DIMENSION AND FIXING HOLES

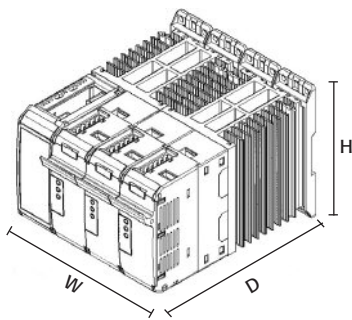

SR11 W 144 mm. - H 121mm. - D 185mm. - kg. 2,4

30A ÷ 45A

