

**MP FILTRI in the world**



**NEW FMP 039**



## NEW FMP 039

MP FILTRI in the world



## WHAT CHANGES

### New FMP 039

#### Head

Aluminum die casting Anodized

#### Housing

Hot forming Anodized

### Benefits new version

- More accurate surface finish
- Increased mechanical strength
- New head design, geometric modification of the internal passages
- Reduction of pressure drop - flow increase

### Old FMP 038

Aluminum gravity Anodized

Aluminum gravity Anodized

$\Delta p$  Body FMP038 Vs. new FMP 039  
oil density 0.86

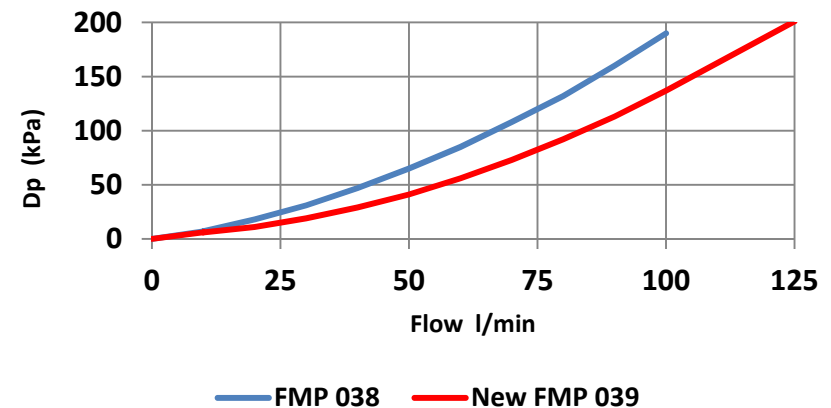

# NEW FMP 039

MP FILTRI in the world



## WHAT CHANGES

New position of the by-pass valve

### Old FMP 038

Valve inserted optionally in one of the two side connections

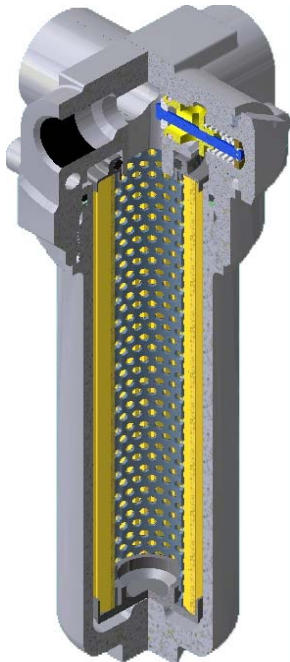

### New FMP 039

By-pass valve mounted in line between the connections IN / OUT

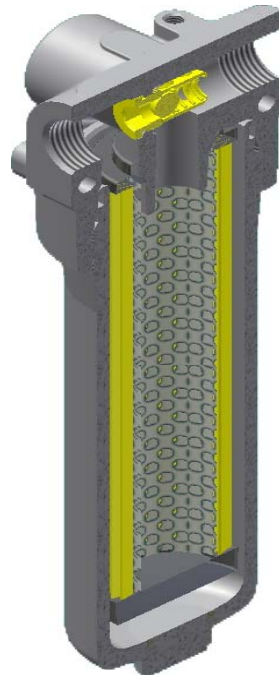

## Benefits new version

New by-pass valve

Better performance, lower pressure drop

$\Delta p$  By-pass FMP 38 Vs. New FMP 039  
Oil viscosity 30 cst.

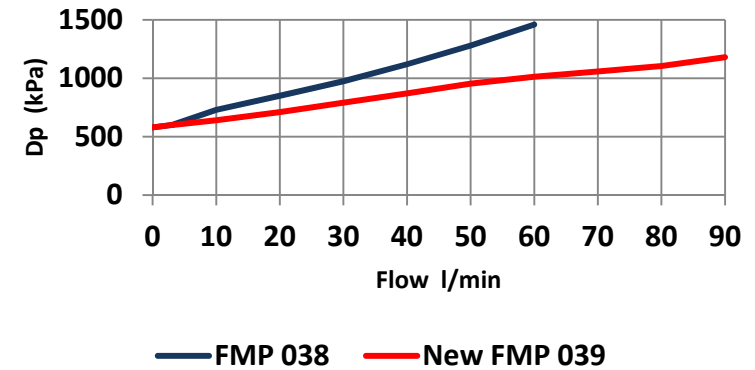

## NEW FMP 039

### WHAT CHANGES

MP FILTRI in the world



#### Dimensions

**New FMP 039**

**Old FMP 038**

No variation in external dimension.

New FMP FMP 039 perfectly interchangeable at the old FMP 038.

#### Benefits new version

In the new version, we added two threaded holes on the head for the possibility of clamping on a horizontal bracket

# NEW FMP 039

MP FILTRI in the world



## WHAT CHANGES

### Mounting Installation

Thanks to the new position of the valve by-pass, the new FMP 039 allows a greater flexibility in mounting.

### Benefits new version

5 Are the possible options for the IN/OUT pipes connection

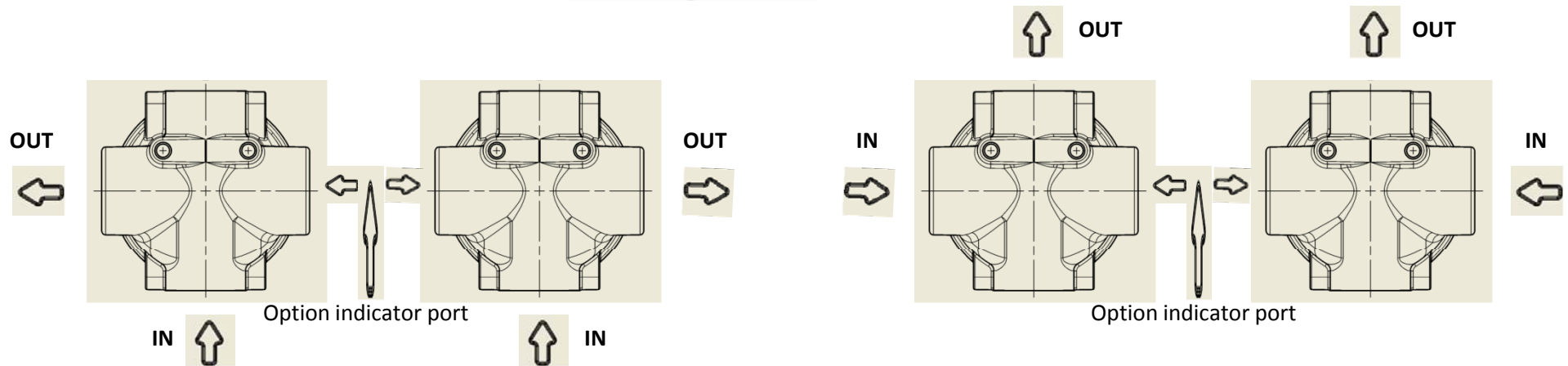
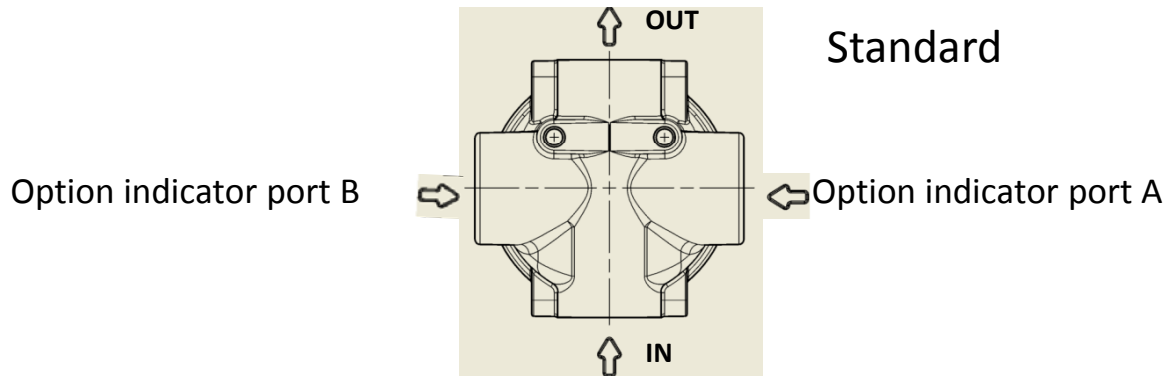

## NEW FMP 039

MP FILTRI in the world



### WHAT CHANGES

Ordering code, filter elements

Old Code filter element for :

FMP038

No dimensional change

NEW Code filter element for :

FMP039

HP 037 1...

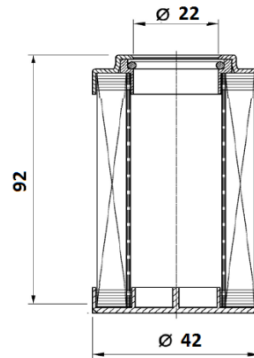

HP 037 5 ...

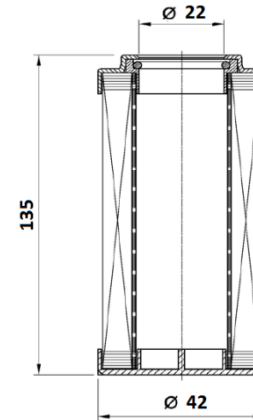

HP 037 2 ...

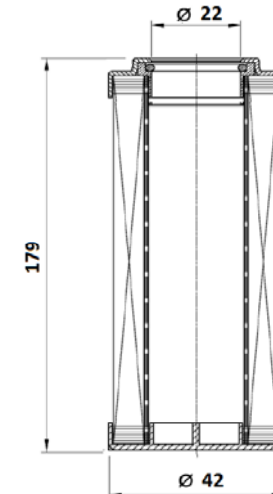

HP 039 2...

HP 039 3 ...

HP 039 4 ...

### Benefits new version

ID alignment between the filter code and filter element

## NEW FMP 039

MP FILTRI in the world



### Headquarter:

MP FILTRI S.p.A. ITALY  
[sales@mpfiltri.com](mailto:sales@mpfiltri.com)



GREAT BRITAIN  
MP FILTRI U.K. Ltd.  
[sales@mpfiltri.co.uk](mailto:sales@mpfiltri.co.uk)

GERMANY  
MP FILTRI Germany GmbH  
[service@mpfiltri.de](mailto:service@mpfiltri.de)

FRANCE  
MP FILTRI FRANCE Sas  
[sales@mpfiltrifrance.com](mailto:sales@mpfiltrifrance.com)

USA  
MP FILTRI USA Inc.  
[sales@mpfiltriusa.com](mailto:sales@mpfiltriusa.com)

CANADA  
MP FILTRI CANADA Inc.  
[Mail@mpfiltricanada.com](mailto:Mail@mpfiltricanada.com)

RUSSIAN FEDERATION  
MP FILTRI RUSSIA  
[mpfiltrirussia@yahoo.com](mailto:mpfiltrirussia@yahoo.com)

CHINA  
MP FILTRI (Shanghai) Co. Ltd.  
[sales@mpfiltrishanghai.com](mailto:sales@mpfiltrishanghai.com)

INDIA & UAE  
MP FILTRI INDIA & UAE  
[s.mishra@mpfiltri.com](mailto:s.mishra@mpfiltri.com)