



INTRODUCTION

The ARON directional control valves NG6 are designed for subplate mounting with an interface in accordance with UNI ISO 4401 - 03 - 02 - 0 - 94 standard (ex CETOP R 35 H 4.2-4-03), and can be used in all fields on account of their high flow rate and pressure capacities combined with compact overall dimensions.

The use of solenoids with wet armatures allows a very practical, safe construction completely dispensing with dynamic seals; the solenoid tube is screwed directly onto the valve chest whilst the coil is kept in position by means of a lock nut.

The special, precise construction of the ports and the improvement of the spools enables relatively high flow rates to be accommodated with a minimal pressure drop (Δp).

The operation of the directional valves may be electrical, pneumatic, oleodynamic, mechanical or lever.

The centre position is obtained by means of calibrated length springs which reposition the spool in the centre or end of travel position once the action of the impulse is over.

The solenoids are constructed with a protection class of IP66 to DIN 40050 standards and are available in either AC or DC form in different voltage and frequencies.

The new type DC coil "D15", of cause their high performance, allows to increasing the limits of use respect to last series.

All types of electrical control are available, on request, with different types of manual emergency controls.

The solenoid coils are normally arranged for DIN 43650 ISO 4400 type connectors; is available on request these variant coils: with AMP Junior connections, with AMP junior and integrated diode, with Deutsch DT04-2P connections or solenoid with flying leads. Connectors with built in rectifiers or pilot lights are also available.

The valves are designed for use with DIN 51524 standard hydraulic mineral oils and it is recommended that filters should be fitted to ensure a maximum contamination level of class 10 in accordance with NAS 1638, $\beta_{25} \geq 75$.

CETOP 3/NG06

STANDARD SPOOLS	CH. I PAGE 10
AD.3.E...	CH. I PAGE 11
AD.3.E...J*	CH. I PAGE 12
AD.3.V...	CH. I PAGE 13
AD.3.L...	CH. I PAGE 14
OTHER OPERATOR	CH. I PAGE 15
AD.3.P...	CH. I PAGE 16
AD.3.O...	CH. I PAGE 16
AD.3.M...	CH. I PAGE 17
AD.3.D...	CH. I PAGE 17
"D15" DC COILS	CH. I PAGE 18
"B14" AC SOLENOIDS	CH. I PAGE 18
STANDARD CONNECTORS	CH. I PAGE 19
"LE" VARIANTS	CH. I PAGE 20
L.V.D.T.	CH. I PAGE 21

PRESSURE DROPS

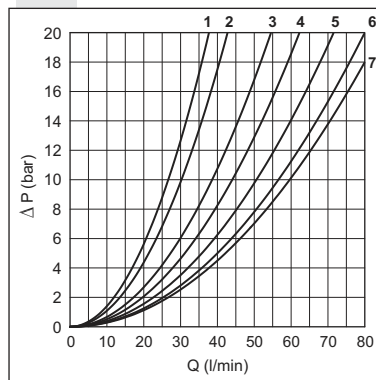

The diagram at the side shows the pressure drop curves for spools during normal usage. The fluid used is a mineral oil with a viscosity of 46 mm²/s at 40°C; the tests have been carried out at a fluid temperature of 40°C. For higher flow rates than those in the diagram, the losses will be those expressed by the following formula:

$$\Delta p_1 = \Delta p \times (Q_1/Q)^2$$

where Δp will be the value for the losses for a specific flow rate Q which can be obtained from the diagram, Δp_1 will be the value of the losses for the flow rate Q_1 that is used.

Spool type	Connections				
	P→A	P→B	A→T	B→T	P→T
01	5	5	5	5	
02	7	7	7	7	6
03	5	5	6	6	
04	2	2	2	2	4
44	1	1	2	2	3
05	7	7	5	5	
06	5	5	7	5	
66	5	5	5	7	
07		2	6		
08	6	6			
09		5		5	

Curve No.

Spool type	Connections				
	P→A	P→B	A→T	B→T	P→T
10	5	5	5	5	
11	5			5	
22		5	5		
12		5		6	
13		5	6	6	
14	4	3	3	3	4
28	3	4	3	3	4
15-19*	5	5	6	6	
16	5	5	4	4	
17-21*	3	4			
20*	4	4	4	4	

Curve No.

(*) Value with energized solenoid

ORDERING CODE

AD	Directional valve
3	CETOP 3/NG6
E	Type of operator For other operator see next pages
**	Spool see page I•10
*	Mounting type (table 1)
*	Voltage (table 2)
**	Variants (table 3)
*	Serial No.
	3 = DC voltage ("D15" coil)
	3 = AC voltage ("B14" solenoid)

Tab.2 - VOLTAGE

AC SOLENOID B14 **	
A	24V/50-60 Hz
B	48V/50-60 Hz
J	115V/50Hz - 120V/60Hz
Y	230V/50Hz - 240V/60Hz
K	AC without coils
Other voltages available on request.	
DC COIL D15 (30W) **	
L	12V
M	24V
V	28V*
N	48V*
Z	102V*
P	110V*
X	205V*
W	DC without coils

115Vac/50Hz
120Vac/60Hz
with rectifier

230Vac/50Hz
240Vac/60Hz
with rectifier

Voltage codes are not stamped on the plate, their are readable on the coils.

* Special voltage
** Technical data see page I • 18

• AMP Junior coils (with or without diode) and coils with flying leads and coils type Deutsch, are available in 12V or 24V DC voltage only.

•The pastic type coil (RS variant) is available in 12V, 24V, 28V or 110V DC voltage only.

Tab.1- MOUNTING

STANDARD	
C	
D	
E	
F	
SPECIALS (WITH PRICE INCREASING)	
G	
H	
I	
L	
M	

• **Mounting type D** is only for valves with detent











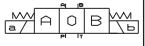









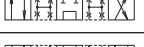
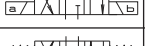
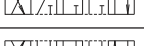
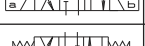
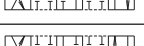
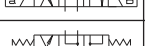
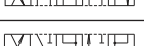
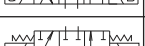
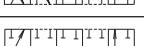



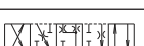

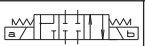

• In case of **mounting D** with detent a maximum supply time of 2 sec is needed (only for AC coils).

Tab.3 - VARIANTS

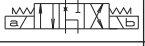









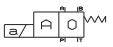







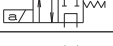

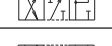
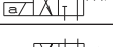
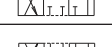

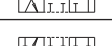
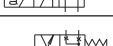
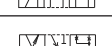
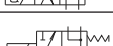
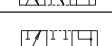
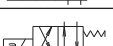

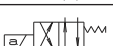
VARIANT	CODE	◆	PAGE
No variant (without connectors)	S1(*)		
Viton	SV (*)		
Emergency control lever for directional control valves type ADC3 and AD3E	LE-LF-AX-CE(*)	◆	I•20
Emergency button	ES(*)		I•18
Rotary emergency button	P2(*)		I•18
Rotary emergency button (180°)	R5(*)		I•18
Preset for microswitch (E/F/G/H mounting only) (see below note ◊)	MS(*)	◆	I•11- I•14
5 micron clearance	SQ(*)	◆	
Spool movement speed control (only VDC) with ø 0.3 mm orifice	3S(*)	◆	I•12
Spool movement speed control (only VDC) with ø 0.4 mm orifice	JS(*)	◆	I•12
Spool movement speed control (only VDC) with ø 0.5 mm orifice	5S(*)	◆	I•12
Spool movement speed control (only VDC) with ø 0.6 mm orifice	6S(*)	◆	I•12
AMP Junior coil - for 12V or 24V DC voltage only	AJ(*)		I•18
AMP Junior coil and integrated diode - for 12V or 24V DC voltage only	AD(*)		I•18
Coil with flying leads (175 mm) - for 12V or 24V DC voltage only	SL		I•18
D15 plastic type coil - for 12V, 24V, 28V or 110V DC voltage only	RS(*)		
Deutsch DT04-2P coil - for 12V or 24V DC voltage only	CZ		I•18
Other variants available on request.			
◊ = Maximum counter-pressure on T port: 8 bar - Microswitch type AM1107 code V79000001 can be ordered separately.			
◆ = Variant codes stamped on the plate			

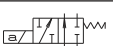
(*) Coils with Hirschmann and AMP Junior connection supplied without connectors. The connectors can be ordered separately, ch. I page 19.

TWO SOLENOIDS, SPRING CENTRED “C” MOUNTING

Spool type		Covering	Transient position
01		+	
02		-	
03		+	
04*		-	
44*		-	
05		+	
66		+	
06		+	
07*		+	
08*		+	
09*		+	
10*		+	
22*		+	
11*		+	
12*		+	
13*		+	
14*		-	
28*		-	

ONE SOLENOID, SIDE A “E” MOUNTING

Spool type		Covering	Transient position
01		+	
02		-	
03		+	
04*		-	
44*		-	
05		+	
66		+	
06		+	
08*		+	
10*		+	
12*		+	
15		-	
16		+	
17		+	
14*		-	
28*		-	

**DIRECTIONAL CONTROL VALVES
STANDARD SPOOLS CETOP 3/NG6**



NOTE

(*) Spool with price increasing











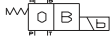





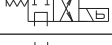

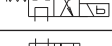
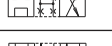

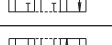
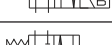
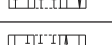

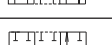
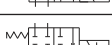
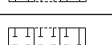
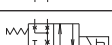







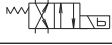

• With spools 15 / 16 / 17 only mounting E / F are possible

• 16 / 19 / 20 / 21 spool not planned for AD.3.E...J*

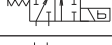
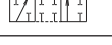





• For lever operated the spools used are different.

Available spools for this kind of valve are: 01 / 02 / 03 / 04 / 05 / 06 / 66 / 07 / 22 / 13 / 15 / 16 / 17

ONE SOLENOID, SIDE B “F” MOUNTING

Spool type		Covering	Transient position
01		+	
02		-	
03		+	
04*		-	
44*		-	
05		+	
66		+	
06		+	
08*		+	
09*		+	
10*		+	
22*		+	
12*		+	
13*		+	
07*		+	
15		-	
16		+	
17		+	
14*		-	
28*		-	

TWO SOLENOIDS “D” MOUNTING

Spool type		Covering	Transient position
19*		-	
20*		+	
21*		+	

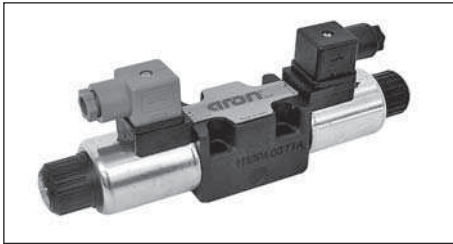

A max. counter-pressure of 8 bar at T is permitted for the variant with a microswitch (MS).
 (*) DC: Dynamic pressure allowed for 2 millions of cycles.
 AC: Dynamic pressure allowed for 350.000 of cycles. For dynamic pressure of 100 bar are allowed 1 milion cycles.

Max. pressure port P/A/B	350 bar
Max. pressure port T (for DC) see note (*)	250 bar
Max. pressure port T (for AC) see note (*)	160 bar
Max. flow	80 l/min
Max. excitation frequency	3 Hz
Duty cycle	100% ED
Fluid viscosity	10 ÷ 500 mm ² /s
Fluid temperature	-25°C ÷ 75°C
Ambient temperature	-25°C ÷ 60°C
Max. contamination level	class 10 in accordance with NAS 1638 with filter β ₂₅ ≥75
Weight with one DC solenoid	1,65 Kg
Weight with two DC solenoids	2 Kg
Weight with one AC solenoid	1,31 Kg
Weight with two AC solenoids	1,72 Kg

CALIBRATED DIAPHRAGMS (**)	
Ø mm	Code
blind	M52.05.0023/4
0.5	M52.05.0023/1
0.6	M52.05.0023/6
0.7	M52.05.0023/8
0.8	M52.05.0023
1.0	M52.05.0023/2
1.2	M52.05.0023/3
1.5	M52.05.0023/7
2.0	M52.05.0023/10
2.2	M52.05.0023/9
2.5	M52.05.0023/5

(**) For high differential pressure please contact our technical department.

OVERALL DIMENSIONS

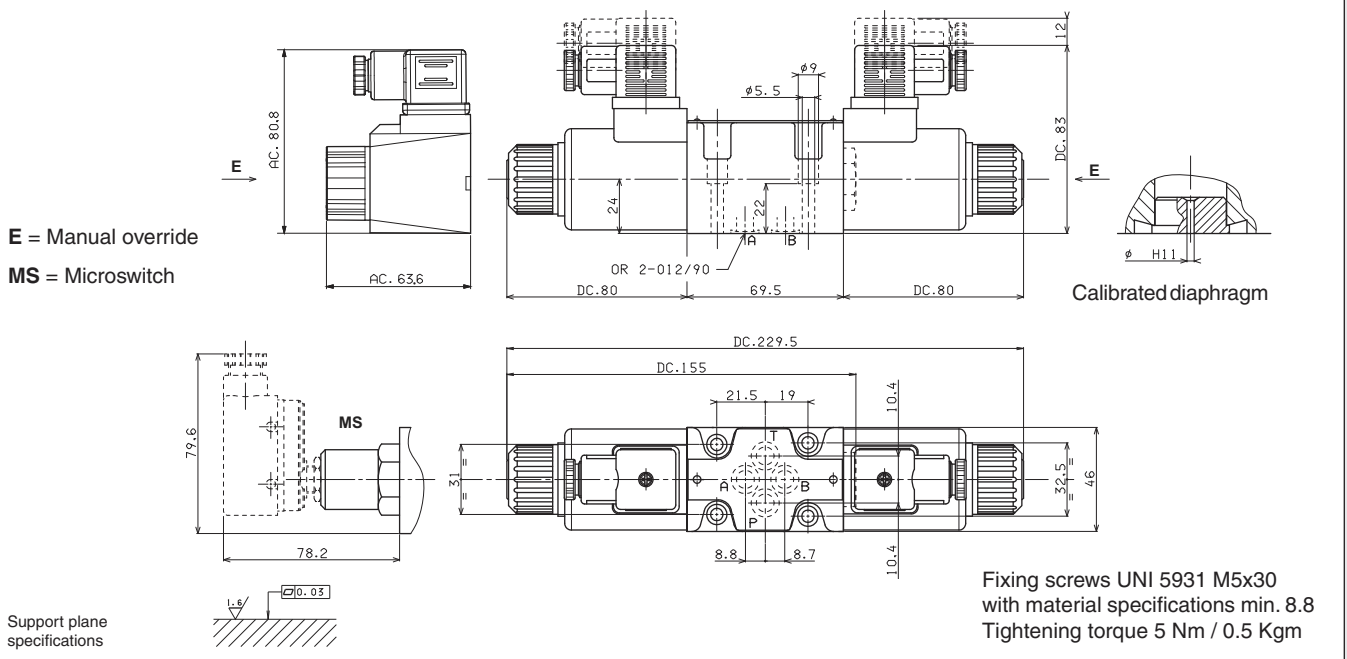

LIMITS OF USE (MOUNTING C-E-F)

The tests have been carried out with solenoids at operating temperature and a voltage 10% less than rated voltage with a fluid temperature of 40°C. The fluid used was a mineral oil with a viscosity of 46 mm²/s at 40°C. The values in the diagram refers to tests carried out with the oil flow in two directions simultaneously T = 2 bar (e.g. from P to A and the same time B to T). In the case where valves 4/2 and 4/3 were used with the flow in one direction only, the limits of use could have variations which may even be negative. Rest times: the values are indicative and depend on following parameters: hydraulic circuit, fluid used and variations in hydraulic scales (pressure P, flow Q, temperature T). The limit of use for AC solenoids were detected with 50 Hz power.

Direct current:	Energizing	30 ÷ 50 ms.	Alternating current:	Energizing	8 ÷ 30 ms.
	De-energizing	10 ÷ 30 ms.		De-energizing	15 ÷ 55 ms.

DIRECT CURRENT SOLENOIDS (DC)

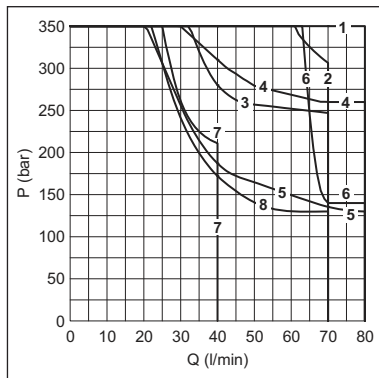

Spool type	Solenoids	
	DC	AC
01	1	9
02	1	9
03	3	10
04	2	15
44	1	9
05	1	16
06-66	5	13
11-22	4	17
14-28	7	12
15	8	14
16	6	11

Curves

ALTERNATING CURRENT SOLENOIDS (AC)

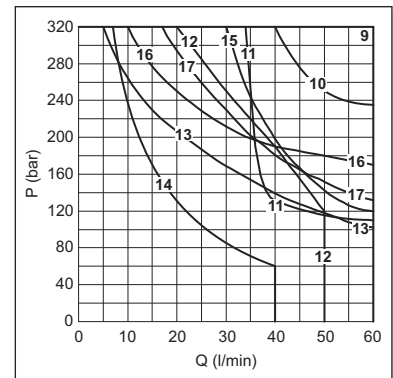

1

Valves type AD3.E...J* with spool movement speed control

These ON-OFF type valves are used a lower spool movement speed than usual for conventional solenoid valves is required to prevent impacts which could adversely affect the smooth running of the system. The system consist of reducing the transfer section for the fluid from one solenoid to the other by means of calibrated orifices.

- This version can only be used with a direct current (DC) and also involves a **reduction in the limits of use so that we suggest to always test the valve in your application**

- To order AD.3...J* version valves, specify the orifices code.
- The operation is linked to a minimum counter-pressure on T line (1 bar min.)
- The switching time referred to the spool travel detected by a LVDT transducer can vary for the NG6 valve from a minimum of 100 to a maximum of 300 ms depending on 5 fundamental variables:
 - 1) Diameter of the calibrated orifices (see table)
 - 2) Hydraulic power for clearance referring to flow and pressure values through valve
 - 3) Spool type
 - 4) Oil viscosity and temperature
 - 5) Counter-pressure at T line

- Possible mountings: C / E / F / G / H
- 16 / 19 / 20 / 21 spools not planned for AD.3.E...J*

Max. pressure ports P/A/B	320 bar
Max. pressure port T (*)	250 bar
Max. flow	30 l/min
Max. excitation frequency	2 Hz
Duty cycle	100% ED
Fluid viscosity	10 ÷ 500 mm ² /s
Fluid temperature	-25°C ÷ 75°C
Ambient temperature	-25°C ÷ 60°C
Weight with one DC solenoid	1,65 Kg
Weight with two solenoids DC solenoids	2 Kg

(*) Pressure dynamic allowed for 2 millions of cycles.

CALIBRATED ORIFICES AVAILABLE		
ø (mm)	M4x4	Code
0.3	M89.10.0028	3S (J3+S1)*
0.4	M89.10.0029	JS (J4+S1)*
0.5	M89.10.0006	5S (J5+S1)*
0.6	M89.10.0030	6S (J6+S1)*

* Old code

OVERALL DIMENSIONS

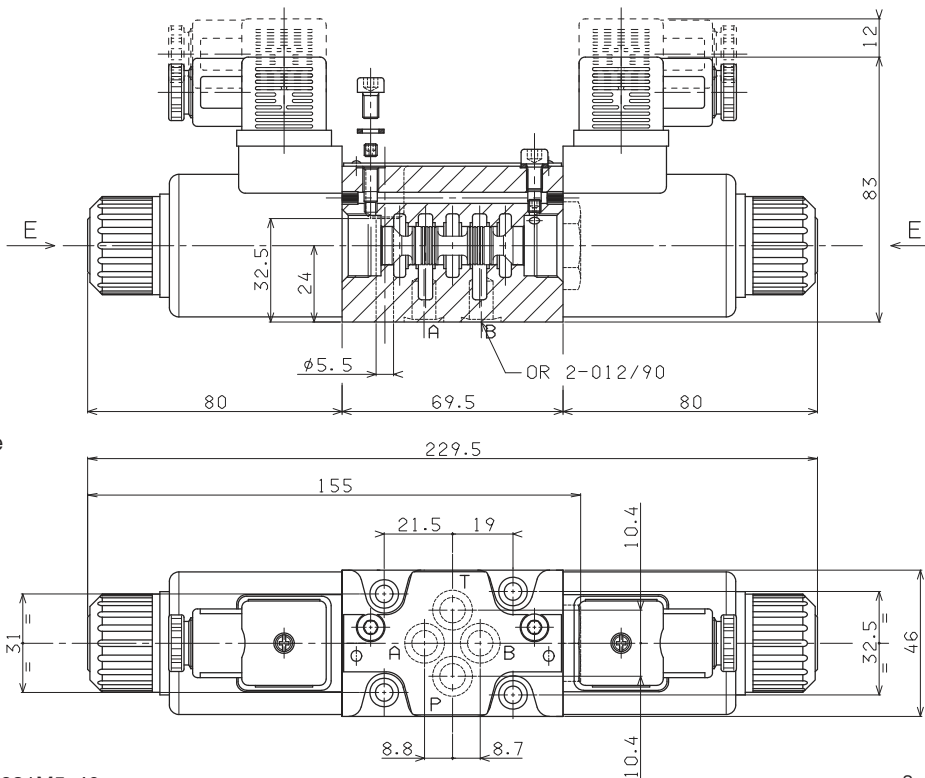

E = Manual override

Fixing screws UNI 5931M5x40
with material specifications min. 8.8
Tightening torque 5 Nm / 0.5 Kgm

Support plane specifications

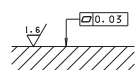

AD.3.V... CETOP 3/NG6 WITH PROXIMITY SENSOR L.V.D.T.

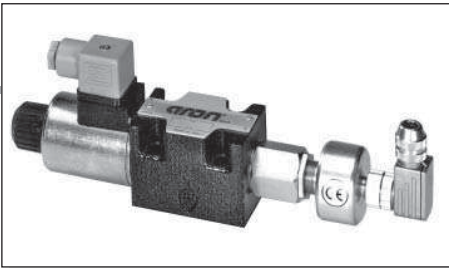

AD.3.V...	
"D15" DC COILS	Ch. I PAGE 18
STANDARD CONNECTORS	Ch. I PAGE 19
L.V.D.T.	Ch. I PAGE 21

The single solenoid directional valves type AD.3.V are used in applications where the monitoring of the position of the spool inside the valve is requested to manage the machine safety cycles in accordance with the accident prevention legislation. These directional valves are equipped with an horizontal positioned inductive sensor on the opposite side of the solenoid, which is capable of providing the first movement of the valve when the passage of a minimum flow is allowed. Integrated in safety systems, these valves intercept actuator movements that could be dangerous for the operators and for the machine.

Max. operating pressure ports P/A/B	350 bar
Max. operating pressure port T dynamic (see note*)	250 bar
Max. flow	60 l/min
Max. excitation frequency	3 Hz
Duty cycle	100% ED
Fluid viscosity	10 ÷ 500 mm ² /s
Fluid temperature	-25°C ÷ 75°C
Ambient temperature	-25°C ÷ 60°C
Type of protection (in relation to connector used)	IP 66
Weight	1,7 Kg

(*) Pressure dynamic allowed for 2 millions of cycles.

- Possible mountings: E / F / H
- The valve is supplied with DC solenoid only

ORDERING CODE

AD	Directional control valve
3	CETOP 3/NG6
V	Directional valve with single solenoid and L.V.D.T. proximity sensor
***	Spool and mounting (table 1)
*	Voltage (table 2)
**	Variants (table 3)
2	Serial No.

CE registered mark for industrial environment with reference to the electromagnetic compatibility. European norms:
 - EN50082-2 general safety norm - industrial environment
 - EN 50081-1 emission general norm - residential environment

PRESSURE DROPS

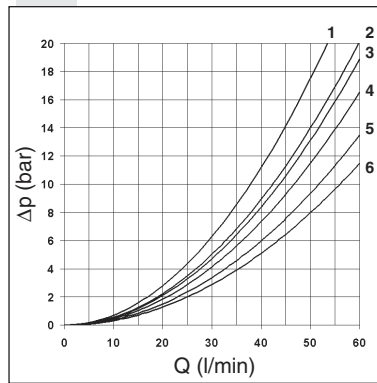

Spool type	Connections				
	P→A	P→B	A→T	B→T	P→T
01	5	5	5	5	5
02	6	6	6	6	
06	5	5	6	5	4
16	5	5	4	4	
17	1	3			6
66	5	5	5	6	
32	1	1	2	2	

Curves No.

The diagram at side shows the Δp curves for spool in normal usage. The fluid used is a mineral oil with a viscosity of 46 mm²/s at 40°C; the tests have been carried out at a fluid temperature of 40°C.

TAB.2 - VOLTAGE

D15 COIL (30W) **	
L	12V
M	24V
V	28V*
N	48V*
Z	102V*
P	110V*
R	205V*
W	Without DC coils and connectors

115Vac/50Hz
120Vac/60Hz
with rectifier

230Vac/50Hz
240Vac/60Hz
with rectifier

Voltage codes are not stamped on the plate, they are readable on the coils.

* Special voltage
 ** Technical data see page I • 18

TAB1 - STANDARD SPOOLS FOR AD3V

Spool type	POSSIBLE MOUNTING: E / F / H		
	Covering	Transient position	
01E	+		
01F	+		
02E	-		
06H*	+		
16E	+		
17F	+		
66F	+		
32E	+		

(*) Spool with price increasing

TAB.3 - VARIANTS

No variant (without connectors)	S1(*)
Viton	SV(*)
Emergency button	ES(*)
Without proximity connector LVDT	S3
Without coils and proximity connector	S4
AMP Junior coil	AJ(*)
AMP Junior coil and integrated diode	AD(*)
Coil with flying leads (175mm)	SL
Deutsch DT04-2P Coil type	CZ

Other variants available on request.

(*) Coils with Hirschmann and AMP Junior connection supplied without connectors. The connectors can be ordered separately, ch. I page 19.

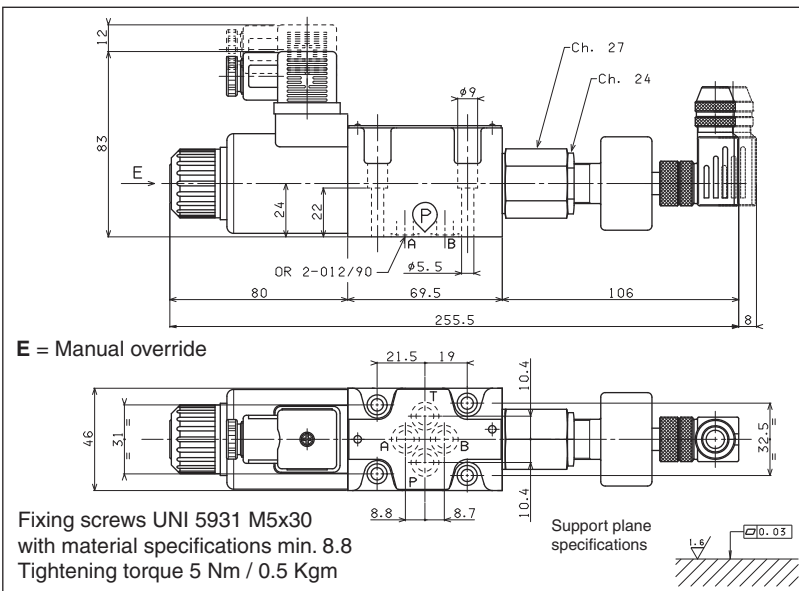

AD.3.L... LEVER OPERATED CETOP 3/NG6



AD.3.L...

STANDARD SPOOLS

CH. I PAGE 10

Max. pressure ports P/A/B	320 bar
Max. pressure port T	160 bar
Max. flow	60 l/min
Lever angle	2 x 17°
Fluid viscosity	10 ÷ 500 mm ² /s
Fluid temperature	-25°C ÷ 75°C
Ambient temperature	-25°C ÷ 60°C
Max. contamination level	class 10 in accordance with NAS 1638 with filter β ₂₅ ≥ 75
Weight	1,2 Kg
Weight M1 variant	1,8 Kg

ORDERING CODE

AD	Directional valve
3	CETOP 3/NG6
L	Lever operation
**	Spool type (see table 1) Spool symbol see page I•10
*	Mounting type (see table 2)
*	Z = Valve with lever X = Valve without lever
*	Variants (see table 3)
4	Serial No.

TAB.1 SPOOLS TYPE

- For these valves spools are different from ones used on the other directional valves
- Available spools:
01 / 02 / 03 / 04 / 05 / 06 / 66
07 / 22 / 13 / 15 / 16 / 17

TAB.2 MOUNTING TYPE

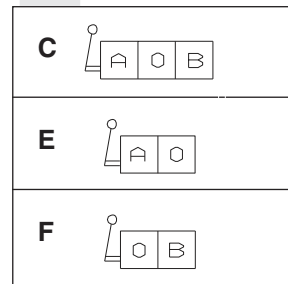

OVERALL DIMENSIONS

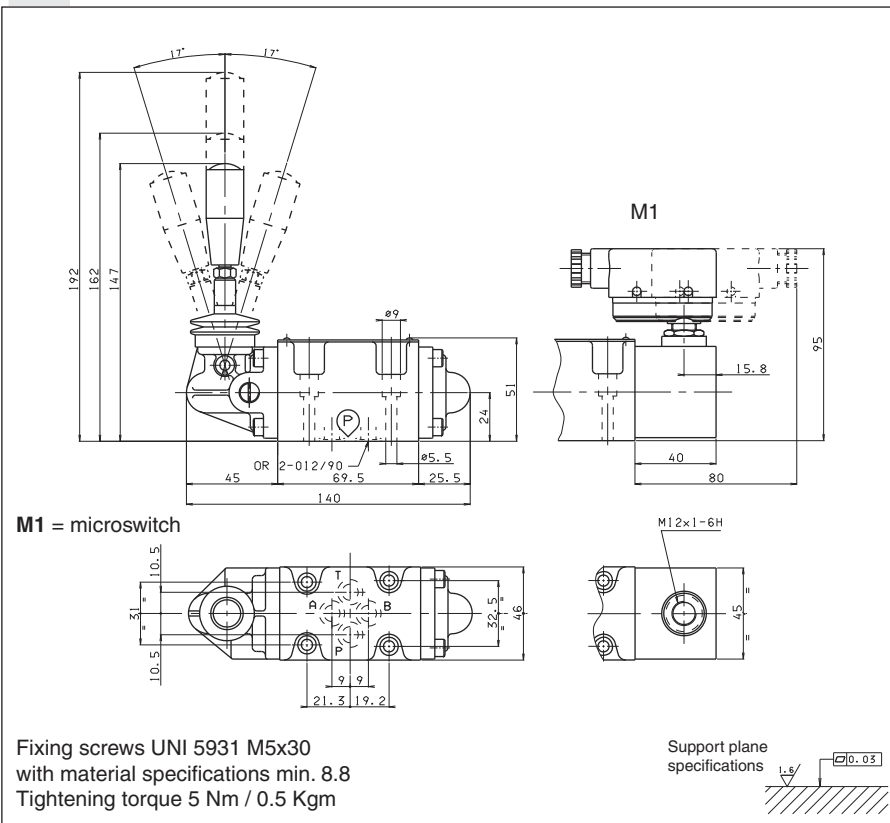
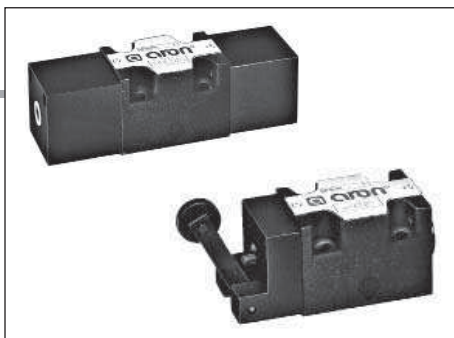

TABLE 3 - VARIANTS TABLE

VARIANTS	CODE (♦)
No variant	00
Viton	V1
Preset for microswitch Microswitch type AM1107 code V79000001 can be ordered separately.	M1 (♦)
Preset for microswitch + Viton	MV (♦)
With detent (*) (mechanical connection) (Springs are different from those for standard versions)	D1 (♦)
Preset for microswitch + Detent (*)	MD (♦)
Lever length 162 mm	L1
Lever length 192 mm	L2
♦ Variant codes stamped on the plate	

(*) max. 150.000 cycles.

DIRECTIONAL CONTROL VALVES OTHER OPERATOR CETOP 3/NG6



OTHER OPERATOR

STANDARD SPOOLS	CH. I PAGE 10
AD.3.P...	CH. I PAGE 16
AD.3.O...	CH. I PAGE 16
AD.3.M...	CH. I PAGE 17
AD.3.D...	CH. I PAGE 17

INTRODUCTION

The ARON directional control valves NG6 are designed for subplate mounting with an interface in accordance with UNI ISO 4401 - 03 - 02 - 0 - 94 standard (ex CETOP R 35 H 4.2-4-03), and can be used in all fields on account of their high flow rate and pressure capacities combined with compact overall dimensions.

The use of solenoids with wet armatures allows a very practical, safe construction completely dispensing with dynamic seals; the solenoid tube is screwed directly onto the valve chest whilst the coil is kept in position by means of a lock nut.

The special, precise construction of the ports and the improvement of the spools enables relatively high flow rates to be accommodated with a minimal pressure drop (Δp).

The centre position is obtained by means of calibrated length springs which reposition the spool in the centre or end of travel position once the action of the impulse is over.

The valves are designed for use with DIN 51524 standard hydraulic mineral oils and it is recommended that filters should be fitted to ensure a maximum contamination level of class 10 in accordance with NAS 1638, $\beta_{25} \geq 75$.

ORDERING CODE

AD	Directional valve
3	CETOP 3/NG06
*	Type of operator P = Pneumatic O = Oleodynamic M = Mechanically D = Direct mechanically (For other operator see past pages)
**	Spool (see page I•10)
*	Mounting type (tab.1)
Z	No voltage
**	Variants: 00 = no variant V1 = Viton H1 = Marine version (for AD3P only) DI(*) = Internal draining (for AD3O only)
2	Serial No.

TAB.1 MOUNTING

STANDARD	
C	
D	
E	
F	
SPECIALS (WITH PRICE INCREASING)	
G	
H	
I	
L	
M	

• In case of **mounting D** with detent a maximum supply time of 2 sec is needed (only for AC coils).

(*) The DI variant is recommended in the environments characterised by the presence of dust or any type of contamination.

PRESSURE DROPS

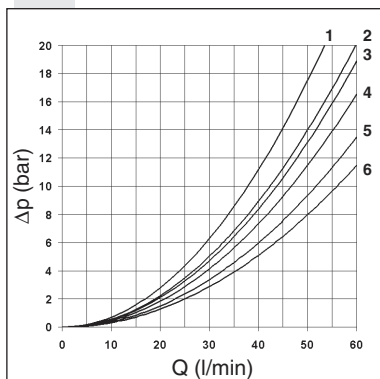

Spool type	Connections				
	P→A	P→B	A→T	B→T	P→T
01	5	5	5	5	
02	6	6	6	6	5
03	5	5	6	6	
04	1	1	2	2	4
05	5	5	5	5	
06	5	5	6	5	
07	5	5	5	6	
08	6	6			
09	5	5		5	
10	5	5	5	5	

Curve No.

Spool type	Connections				
	P→A	P→B	A→T	B→T	P→T
11	4			6	
22		4	6		
12		5		6	
13		5	6	6	
14	2	1	1	1	2
28	1	2	1	1	2
15 - 19	4	4	6	6	
16	5	5	4	4	
17 - 21	1	3			
18	5	5			
20	4	4	4	4	

Curve No.

The diagram at the side shows the pressure drop curves for spools during normal usage. The fluid used is a mineral oil with a viscosity of 46 mm²/s at 40°C; the tests have been carried out at a fluid temperature of 40°C. For higher flow rates than those in the diagram, the losses will be those expressed by the following formula:

$$\Delta p_1 = \Delta p \times (Q_1/Q)^2$$

where Δp will be the value for the losses for a specific flow rate Q which can be obtained from the diagram, Δp_1 will be the value of the losses for the flow rate Q1 that is used.

AD.3.P... PNEUMATIC OPERATION TYPE VALVES CETOP 3/NG6

1

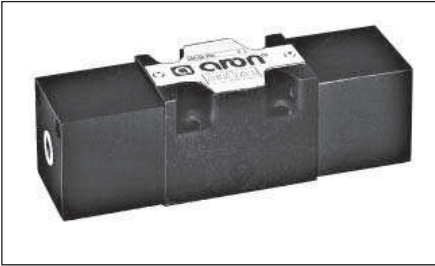

Max. pressure ports P/A/B	320 bar
Max. pressure port T	160 bar
Max. flow	60 l/min
Minimum operating pressure	$2 + [0.027 \times (pt^*)]$ bar - see note
Maximum operating pressure	20 bar
Fluid viscosity	$10 \div 500 \text{ mm}^2/\text{s}$
Fluid temperature	$-25^\circ\text{C} \div 75^\circ\text{C}$
Ambient temperature	$-25^\circ\text{C} \div 60^\circ\text{C}$
Max. contamination level	class 10 in accordance with NAS 1638 with filter $\beta_{25} \geq 75$
Weight single pilot	1,2 Kg
Weight twin pilot	1,8 Kg

• Possible mountings:
C/D/E/F/G/H/I L/M

Ordering code see page before

(pt*)=pressure at port T

OVERALL DIMENSIONS

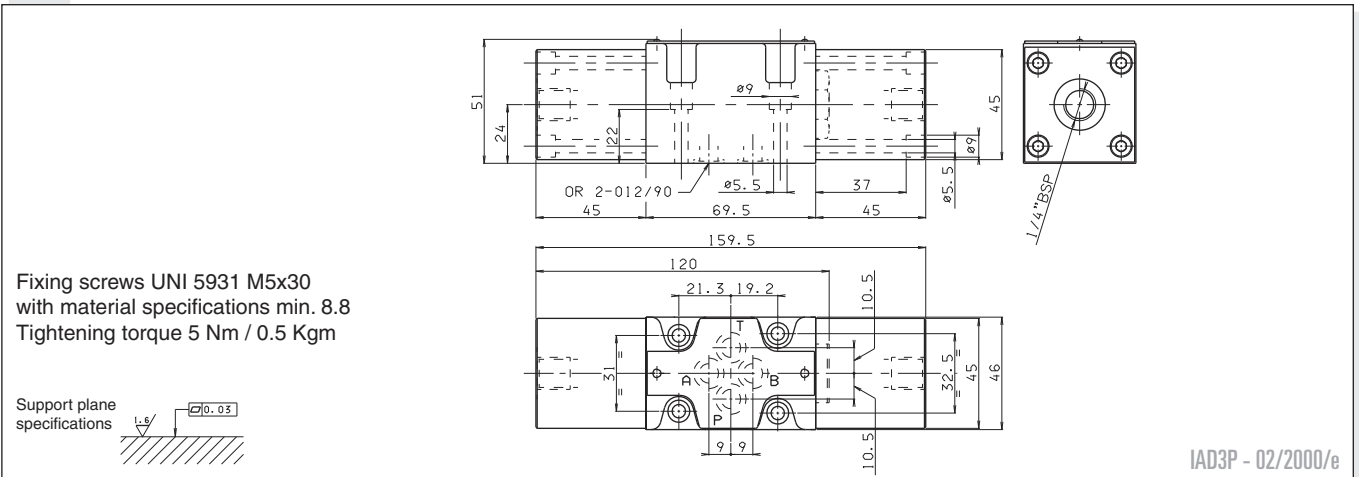

AD.3.O... OLEODYNAMIC OPERATION TYPE VALVES CETOP 3/NG6

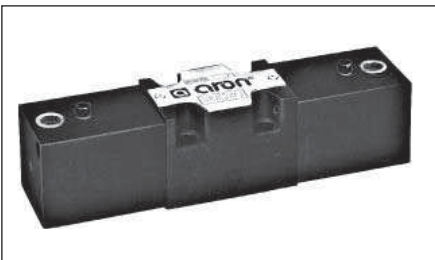

Max. pressure ports P/A/B	320 bar
Max. pressure port T	160 bar
Max. flow	60 l/min
Minimum operating pressure	$15 + [0.1 \times (pt^*)]$ bar - see note
Maximum operating pressure	250 bar
Fluid viscosity	$10 \div 500 \text{ mm}^2/\text{s}$
Fluid temperature	$0^\circ\text{C} \div 75^\circ\text{C}$
Ambient temperature	$-25^\circ\text{C} \div 60^\circ\text{C}$
Max. contamination level	class 10 in accordance with NAS 1638 with filter $\beta_{25} \geq 75$
Weight single pilot	1,5 Kg
Weight twin pilot	2,3 Kg

• Possible mountings:
C/D/E/F/G/H/I L/M

Ordering code see page before

(pt*)=pressure at port T

The DI variant is recommended in the environments characterised by the presence of dust or any type of contamination.

Further technical specifications (for DI variant only)

Minimum operating pressure	$[10 + (pt^*)]$ bar - see note
Maximum operating pressure	250 bar
Max. piloting leakage	1 l/min

OVERALL DIMENSIONS

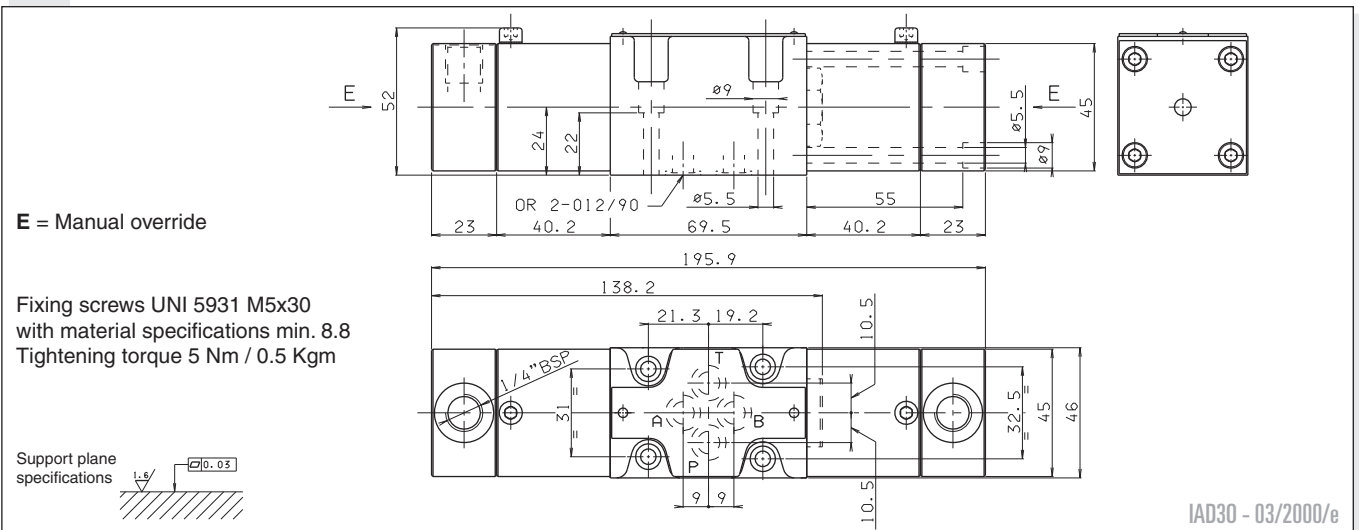

AD.3.M... MECHANICALLY OPERATED TYPE VALVES CETOP 3/NG6



1

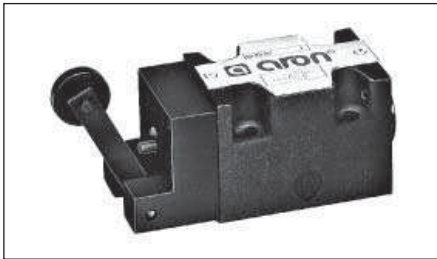

Max. pressure ports P/A/B	320 bar
Max. pressure port T	160 bar
Max. flow	60 l/min
Minimum operating force - see note (*)	2,5 Kg
Maximum operating force - see note (**)	13 Kg
Cam angle	27°
Fluid viscosity	10 ÷ 500 mm ² /s
Fluid temperature	-25°C ÷ 75°C
Ambient temperature	-25°C ÷ 60°C
Max. contamination level	class 10 in accordance with NAS 1638 with filter $\beta_{25} \geq 75$
Weight	1 Kg

- Possible mountings: E / F / G / H
- Ordering code see page before
- Note:
 - (*) In the absence of counter-pressure at port T
 - (**) with a pressure of 160 bar at port T

OVERALL DIMENSIONS

Stroke	12,4 mm
Working stroke	3 mm

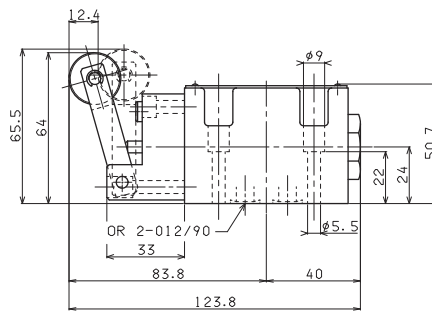

Fixing screws UNI 5931 M5x30 with material specifications min. 8.8
Tightening torque 5 Nm / 0.5 Kg

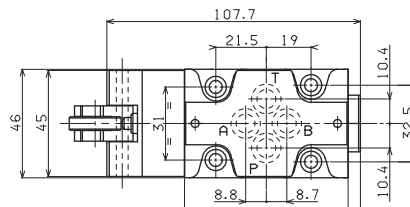
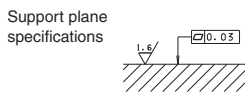

EAD3M - 02/2000/e

AD.3.D... DIRECT MECHANICALLY OPERATED TYPE VALVES CETOP 3/NG6



Max. pressure ports P/A/B	320 bar
Max. pressure port T	20 bar
Max. flow	60 l/min
Operating force - see note (*)	6 Kg
Fluid viscosity	10 ÷ 500 mm ² /s
Fluid temperature	0°C ÷ 75°C
Ambient temperature	-25°C ÷ 60°C
Max. contamination level	class 10 in accordance with NAS 1638 with filter $\beta_{25} \geq 75$
Weight	1,5 Kg

- Possible mountings: E / F / G / H
- Ordering code see page before
- Note:
 - (*) In absence of counter-pressure at port T

OVERALL DIMENSIONS

Stroke	6 mm
Extra stroke	2 mm
Working stroke	3 mm

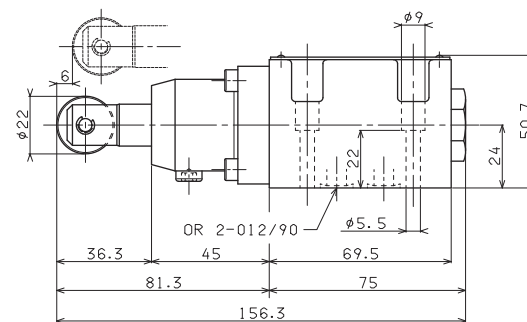

Fixing screws UNI 5931 M5x30 with material specifications min. 8.8
Tightening torque 5 Nm / 0.5 Kg

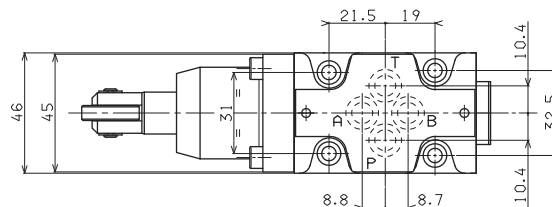
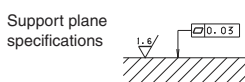

EAD3D - 02/2000/e

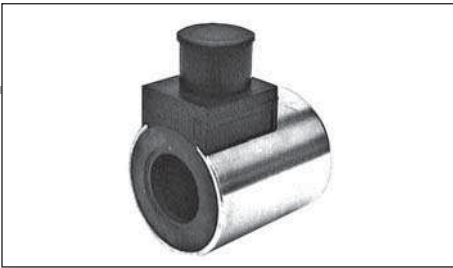

"D15" DC COILS FOR CETOP 3



Type of protection (in relation to the connector used)	IP 66
Number of cycles	18.000/h
Supply tolerance	±10%
Ambient temperature	-54°C ÷ 60°C
Duty cycle	100% ED
Insulation class wire	H
Weight	0,354 Kg

- AMP Junior coils (with or without diode) and coils with flying leads and coils type Deutsch, are available in 12V or 24V DC voltage only.
- The pastic type coil (RS variant) is available in 12V, 24V, 28V or 110V DC voltage only.

VOLTAGE (V)	MAX WINDING TEMPERATURE (AMBIENT TEMPERATURE 25°C)	RATED POWER (W)	RESISTANCE AT 20°C (OHM) ±10%
12V	110°C	30	4.8
24V	110°C	30	18.8
28V*	110°C	30	25.6
48V*	110°C	30	75.2
102V(**)**	110°C	30	340
110V(**)**	110°C	30	387
205V(**)**	110°C	30	1375

* Special voltages

** The european low voltage directive is applied to electrical equipments used at a nominal voltages between 50 and 1000 VAC or 75 and 1500 VDC. In conformity with the low directive each part of the manifold or the subplate on which the valve is mounted should be connected to a protective earth with a resistance less than 0.1 ohms.

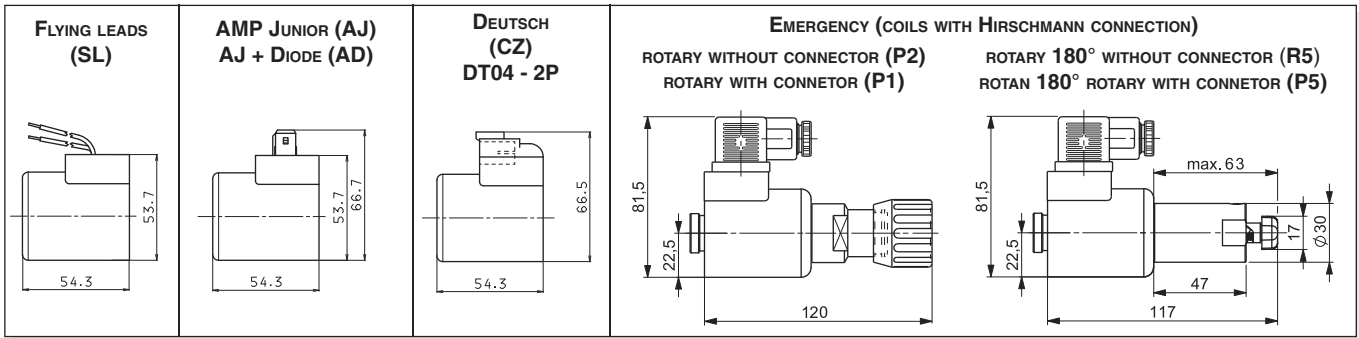
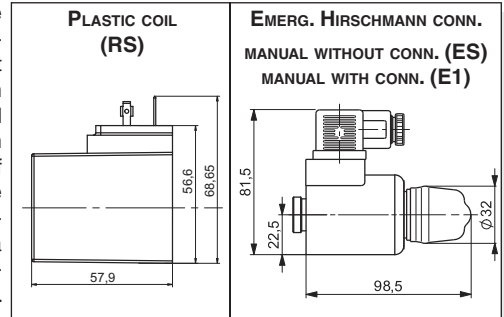

"B14" AC SOLENOIDS FOR CETOP 3



Type of protection (in relation to the connector used)	IP 65
Number of cycles	18.000/h
Supply tolerance	+10% / -10%
Ambient temperature	-30°C ÷ 60°C
Duty cycle	100% ED
Insulation class wire	H
Weight	0,436 Kg

VOLTAGE (V)	MAX. WINDING TEMPERATURE (AMBIENT TEMPERATURE 25°C)	RESISTANCE AT 20°C (OHM) ±10%	RATED POWER. (VA)	PICKUP CURRENT (A)
24V/50Hz - 24V/60Hz	100°C - 96°C	1.7	54 - 40	5.6 - 5
48V/50Hz - 48V/60Hz	112°C - 98°C	6.8	45 - 34	5.3 - 5
115V/50Hz - 120V/60Hz *	133°C - 101°C	32.5	61 - 51	3.2 - 3.2
230V/50Hz - 240V/60Hz *	120°C - 103°C	134	62 - 52	1.6 - 1.6

* The european low voltage directive is applied to electrical equipments used at a nominal voltages between 50 and 1000 VAC or 75 and 1500 VDC. In conformity with the low directive each part of the manifold or the subplate on which the valve is mounted should be connected to a protective earth with a resistance less than 0.1 ohms.

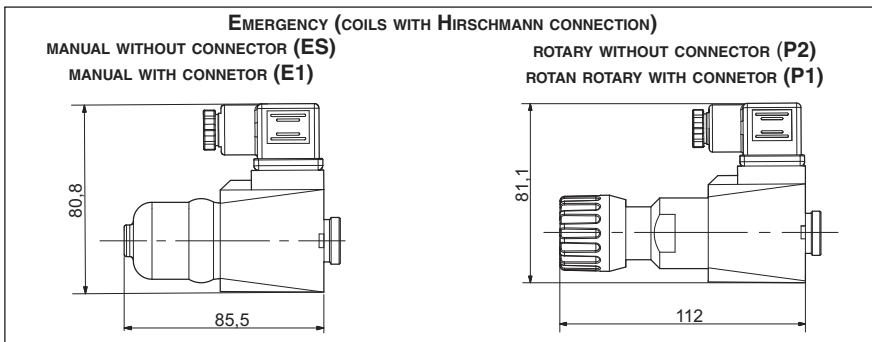

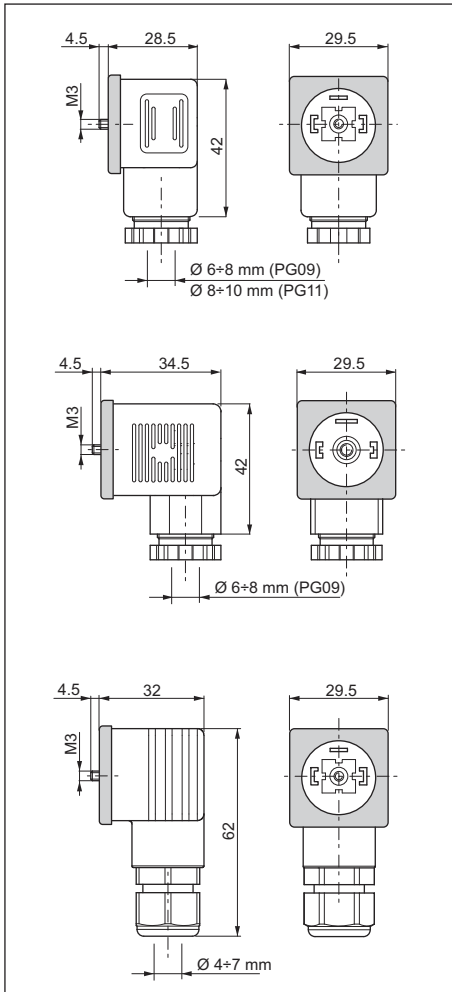

Connector	Protection level	Type	Cable gland	Code
Standard	IP65	Black color	PG09	V86 05 0002
		Grey color	PG09	V86 05 0004
		Black color	PG11	V86 05 0006
		Grey color	PG11	V86 05 0008
Lens cover with pilot light (*)	IP65	12 VAC/VDC	PG09	V86 10 0018
		24 VAC/VDC	PG09	V86 10 0012
		115 VAC/VDC	PG09	V86 10 0020
		230 VAC/VDC	PG09	V86 10 0022

Screw tightening torque: 0.60 Nm

Connector	Protection level	Type	Cable gland	Code
With rectifier (*) Inlet voltage 12÷230 VAC Outlet voltage 9÷205 VDC	IP65	Black color	PG09	V86 20 0002
		Grey color	PG09	V86 20 0004
Lens cover with pilot light and rectifier (*) Inlet voltage 12÷230 VAC Outlet voltage 9÷205 VDC	IP65	12 VAC	PG09	V86 25 0018
		24 VAC	PG09	V86 25 0019
		48 VAC	PG09	V86 25 0020
		115 VAC	PG09	V86 25 0021
		230 VAC	PG09	V86 25 0022

Screw tightening torque: 0.60 Nm

Connector	Protection level	Type	Cable gland	Code
With protection level IP67	IP67	Black color	—	V86 28 0001
		Grey color	—	V86 28 0002

Screw tightening torque: 0.60 Nm

(*) Don't use for proportional versions

ELECTRICAL FEATURES OF CONNECTORS

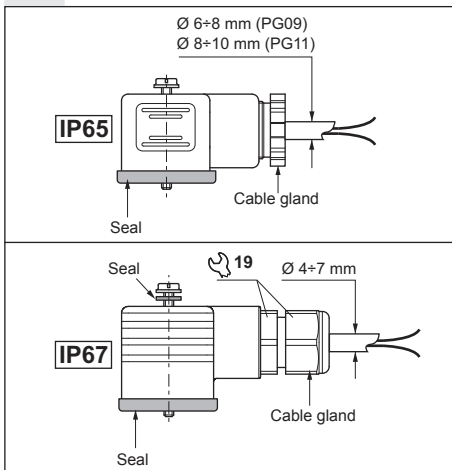

Description	IP65	IP67
AC rated voltage	Max. 250 V	Max. 250 V
DC rated voltage	Max. 300 V	Max. 300 V
Pin contact nominal current	10A	10A
Pin contact max. current	16A	16A
Max. section cable	1.5 mm ²	1.5 mm ²
Cable gland PG09 - M16x1,5	Ø cable 6 ÷ 8 mm	Ø cable 4 ÷ 7 mm
Cable gland PG11 - G 1/2" - M20x1,5	Ø cable 8 ÷ 10 mm	—
Protection level	IP65 EN60529	IP67 EN60529
Insulation class	VDE 0110-1/89	VDE 0110-1/89
Operating temperature	-40°C ÷ 90°C	-20°C ÷ 80°C

The degrees of protection indicate is guaranteed only if the connectors were properly mounted with his original seals.

AMP JUNIOR CONNECTORS

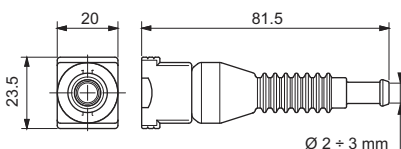

Connector	Type	Cable section	Pin contact max current	Code
AMP Junior connector Timer 2 contact	Black color	0,5 ÷ 1,5 mm ²	10A	RKRC0808000