



Ceramic Infrared Emitters

Contents

Contents Page

Technique and safety 4

- Basic physics 4-5
- Application examples 6
- Planning guidelines 7
- Radiation distribution 8
- Performance 9
- Power adjustment 10
- General information 11
 - heater's mounting
 - service life
 - explosion protection
 - aggressive media
- Safety instructions 12
- Summary 13

Elstein infrared emitters 14

Elstein standard assortment of infrared heaters
Product survey on page 3

Elstein infrared systems 34

Elstein standard assortment of infrared systems
Product survey on page 3

Elstein accessories 42

- Elstein standard assortment for
- temperature control
 - electrical and mechanical connection
 - building of heating areas

Further Elstein products 46

Further infrared heaters, IR Systems
and accessories.

Alphabetical product survey

Type	Page	Type	Page	Type	Page	Type	Page
AK	43	HFS	46	IRS/330	47	SBM	47
BSH	49	HLF	46	IRS/K	47	SFH	24
BSI	40	HLF/S	46	ISN	47	SHTS	20
EBF	36	HLS	28	ISS	47	SHTS/100	46
EBF-R	49	HSR	22	KSS/60	48	SSH	48
EBI	38	HTS	18	LCR	46	SSV	48
EBI-R	49	IOT/75	32	MBO	45	TRD 1	43
EBO	45	IOT/90	32	MPO	45	TSE	43
FIS	49	IPO	48	MSH	26	URG	43
FSF	46	IPT	48	PST	43	WKS	50
FSL	47	IRH	50	REF	34		
FSM	16	IRH/S	50	REO	45		
FSR	14	IRS	30	RFS	48		

Elstein Infrared Emitters

...wavelengths ahead

The company Elstein-Werk was established in Northeim 1950 as the only factory worldwide specialised in manufacturing ceramic infrared heaters. Even then infrared heaters have been developed on the basis of own patents and processes, whose design and quality have determined the state of the art standards to this day.

Through continuous pioneer work and further development of our products, technically and economically interesting fields of application have been and are still being developed for infrared heating.

Today Elstein infrared emitters solve all kinds of heating and drying tasks. Together with the proven modular systems, heating areas with a high power density and selective energy application can be realised in the material to be heated. The controllability of the heat output using modern digital temperature controllers and thyristor switching units ensures optimum use of energy and therefore helps to save operating costs and to protect the environment.

A wide range is available for the initial installation, modifications or for extending machines and plants, which is and can be adjusted to the needs of the heating tasks or the drying process.















This technical brochure provides information about possible uses of Elstein products. We will be pleased to advise you on how to solve your specific heating task.

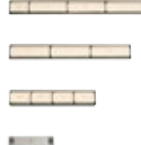

Figure 1: The company Elstein-Werk in Northeim

Product survey

The company Elstein-Werk is developer, patent holder and manufacturer of ceramic infrared heaters. The assortment contains infrared heaters, IR systems and accessories. This product survey also represents the state-of-the-art for this kind of electrical heating elements worldwide.

FSR series Proved quality 245 x 60 mm 122 x 60 mm 60 x 60 mm	typ. up to 720 °C max. 64.0 kW/m ² 2-10 µm		Page 14-15	IRS series Rod heater 245 x 16 mm 122 x 16 mm	typ. up to 650 °C max. 72.0 kW/m ² 2-10 µm		Page 30-31
MaxLife FSM series Maximum service life 245 x 60 mm 122 x 60 mm 60 x 60 mm	typ. up to 720 °C max. 64.0 kW/m ² 2-10 µm		Page 16-17	IOT-75/90 series Easy connection (E27) Ø 75 mm Ø 90 mm	typ. up to 490 °C max. 25.0 kW/m ² 3-10 µm		Page 32-33
HTS series Energy saving 122 x 122 mm 245 x 60 mm 122 x 60 mm 60 x 60 mm	typ. up to 860 °C max. 64.0 kW/m ² 2-10 µm		Page 18-19	REF series Infrared heater with reflector 250 x 95 mm 125 x 95 mm	typ. up to 860 °C max. 48.0 kW/m ² 2-10 µm		Page 34-35
SHTS series Max. power, panel heater 122 x 122 mm 245 x 60 mm 122 x 60 mm 60 x 60 mm	typ. up to 860 °C max. 76.8 kW/m ² 2-10 µm		Page 20-21	EBF and EBI series IR system, variable geometries 100 x 250 to 100 x 1250 mm Other lengths on request	typ. up to 860 °C max. 48.0 kW/m ² 2-10 µm		Page 36-39
HSR series Short heat-up and cool-down time 122 x 122 mm 245 x 60 mm 122 x 60 mm	typ. up to 860 °C max. 64.0 kW/m ² 2-10 µm		Page 22-23	BSI series IR system, even geometry 62.5 x 125 to 1000 x 1500 mm Other sizes on request	typ. up to 860 °C max. 64.0 kW/m ² 2-10 µm		Page 40-41
SFH series Flat, space saving installation 123 x 123 mm 246 x 61 mm 123 x 61 mm 61 x 61 mm	typ. up to 800 °C max. 64.0 kW/m ² 2-10 µm		Page 24-25	Accessories Heater's control and connection Controller Thyristors Fuse holders Fuses	Cables Terminals		Page 42-43
MSH/20 Smallest ceramic heater 20 x 10 mm Width: 10 mm	typ. up to 900 °C max. 100 kW/m ² 2-10 µm		Page 26-27	Metal Accessories For building heating areas Housings Sheets Profiles	Heater's fixing		Page 44-45
HLS series Max. power, rod heater 245 x 32 mm 122 x 32 mm	typ. up to 1000 °C max. 87.0 kW/m ² 2-10 µm		Page 28-29	Further products Flexibility / Diversity Further heater designs	Further infrared systems and accessories		Page 46-50

Basic Physics

Range	Wavelength
Microwave	100 μm
IR radiation	10 μm
Light	1 μm
UV radiation	0,1 μm

Figure 2: Wavelength ranges

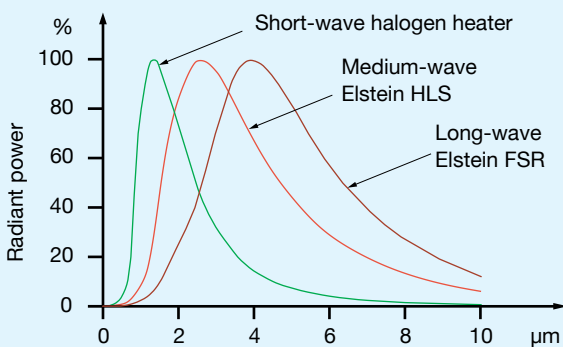

Figure 3: Spectral radiant power

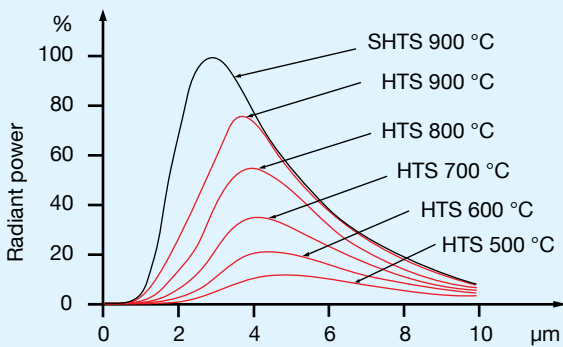

Figure 4: Spectral radiant power of Elstein heaters

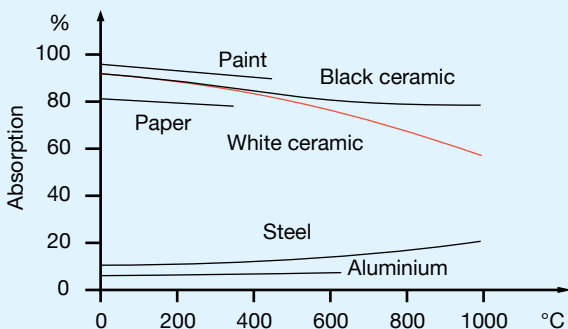

Figure 5: Absorption of various materials

Infrared radiation is the term used to describe the emission and transmission (propagation) of electromagnetic waves within the spectral range above visible light from 0.7 μm up to around 80 μm . This emission and transmission of the electromagnetic waves is associated with the specific, directional transport of energy. The transmission of energy does not require a transport medium and is therefore also possible in a vacuum.

Infrared heaters are classified according to their wavelength maximum of the spectral radiant power into short, medium and long-wave heaters. In short-wave infrared heaters the maximum is less than 1.5 μm . Long-wave infrared heaters are those whose maximum lies above 3 μm . Between them are the medium-wave infrared heaters. Figure 3 shows the spectral power distribution of several typical heaters in these classes. In general, the higher the temperature of a heater, the shorter the wavelength of the radiation.

The power emitted depends on the temperature of the heater and its surface. Figure 4 shows the spectral power distribution of Elstein's SHTS and HTS infrared heaters at different surface temperatures. As you can see, at the same temperature, the black SHTS emits considerably more than the white HTS. However, the positive influence of a black glaze only becomes noticeable after temperatures have exceeded 800 $^{\circ}\text{C}$. Figure 4 also shows that, due to the radiation properties of the white glaze, the spectral radiant power of HTS heaters is virtually independent of the temperature.

All materials have different radiation values, as they partly reflect the radiation or, as it is the case with glass, let it pass through. Figure 5, for example, shows the absorption of bright aluminium and ceramic. Aluminium only absorbs about 15 %, the rest is reflected. Ceramic on the other hand absorbs about 90 % of the radiation. As absorption and emission are based on the same physical causes in each body, it is clear that ceramic is ideally suited as a material for infrared heaters.

The power emitted by a heater roughly depends on the fourth power of the absolute temperature (cf. Figure 4). Therefore, infrared heaters are usually operated at temperatures from 300 $^{\circ}\text{C}$ in order to achieve good efficiencies. In practice it must also be taken into consideration that the heated material also emits infrared radiation. Therefore, only the difference between the respective radiant powers actually heats the material.

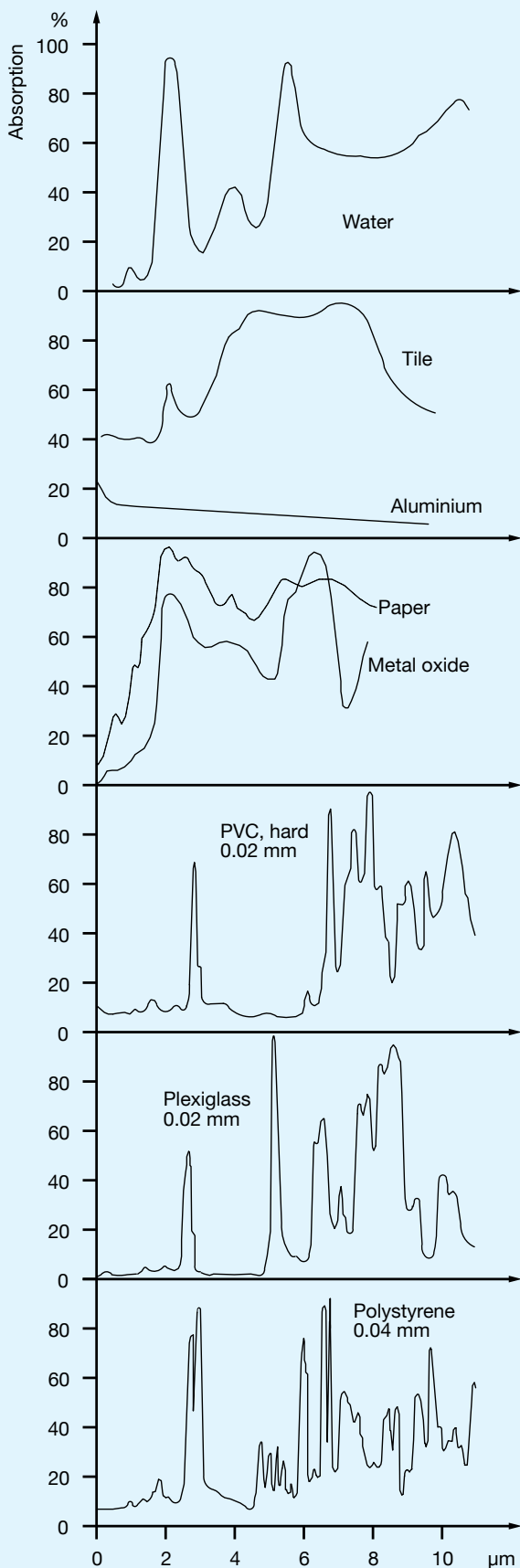

Figure 6: Spectral absorption of various materials

Apart from a few subtle differences, the absorption spectra of many materials in the medium and long-wave infrared range are very similar (Figure 6). While metal oxides and mineral materials absorb consistently well from around 3 μm , plastics with small layer thicknesses show characteristic absorption bands. In these wavelength ranges the absorption of energy is particularly favourable. Radiation in the other wavelength ranges is reflected or transmitted. This is significant when heating thin plastic foils, whereby the addition of small amounts of pigments can considerably improve the absorption properties. In practice, Elstein infrared emitters have proven to be particularly favourable for this application.

Elstein infrared heaters emit over a broad wavelength range. It is therefore not necessary to match the maximum absorption of the material to be heated with the emission maximum of the heater. Whether the energy is absorbed by the material at a wavelength of 3 μm or at 6 μm is not important. Important is that the material to be heated has good absorption properties and the provision of the required heating power.

When bright or polished metals are heated on the other hand the absorption is hardly noticeable. The infrared radiation is primarily reflected. The reflectance is determined by the electrical conductivity and the surface quality of the metal. Slight changes in the surface property, e.g. greater roughnesses, oxide coats (cf. Figure 6) or paint layers, also enable heating by infrared radiation in these cases.

The use of infrared heaters for drying materials is particularly significant. As Figure 6 shows, water has a broad absorption spectrum in the medium to long-wave range. For this reason, drying and evaporation tasks can also be advantageously solved using Elstein infrared emitters.

Elstein infrared emitters ideally fulfil the various requirements of practical situations, and not only with respect to the high heater emissivity but also the optimum wavelength range for heating appropriate for the material involved.

The data sheets and the heaters themselves list the limit temperatures to be observed. These limit temperatures should not be exceeded because it can damage the ceramic.

Application Examples

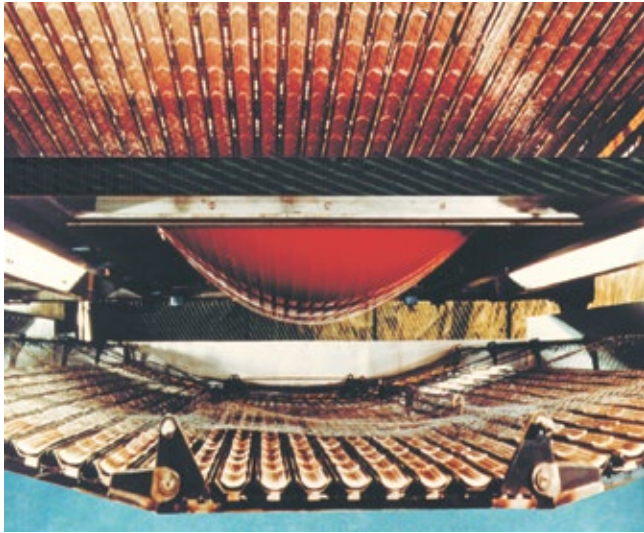

Figure 7: Thermoforming plant for boat hulls



Figure 8: 3-D heating panel for laminating door trims



Figure 9: Paint dryer for electric motors

Application examples for the use of Elstein infrared emitters:

- Heating plastic foils and sheets in thermoforming machines
- Production of shrink foils and films
- Gelling PVC pasty coats on fabrics
- Heating GRP and CRP parts during production
- Thermofixation of nylon and perlon threads
- Activating glues and hot seal coats
- Drying plastic emulsions
- Heating laminated materials before punching
- Drying raw and printed papers, cardboards and wallpapers
- Drying skins, hides and paint sprayed leather
- Quick-drying gummed papers
- Drying and baking enamelled sheet metal parts
- Baking on powder coatings
- Drying glazes on ceramic tiles
- Tempering glass
- Drying washed glass
- Soldering printed circuit boards
- Pre-heating weld seams in pipe construction
- Baking on sound insulating mats
- Drying fireproof impregnations for illumination and decorative papers
- Heating climatic chambers
- Drying washed, dyed and dressed fabric
- Baking on fluidised bed coatings
- Drying glued wood or furniture pieces
- Heating the paper mash before it is squeezed
- Pre-heating plastic pipes for joining
- Curing epoxy resins
- Tempering injection mouldings
- Drying raw tobacco
- Heating dragée masses
- Baking and browning biscuits
- Melting icing or chocolate frosting
- Keeping meals warm
- Heating processed cheese
- Keeping outdoor switchgear cabinets dry
- Accelerating chemical conversions
- Therapeutic medical radiation
- Infrared heated cabins (wellness cabins)
- Sterilising food packagings

This list could be continued ad infinitum. This is because almost all application, production, handling as well as refining processes involve drying or heating tasks, and these can be solved outstandingly well using Elstein infrared emitters.

Planning Guidelines

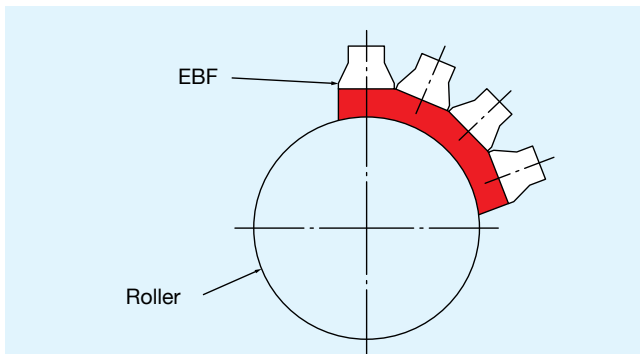

Figure 10: Roller heating using the EBF system

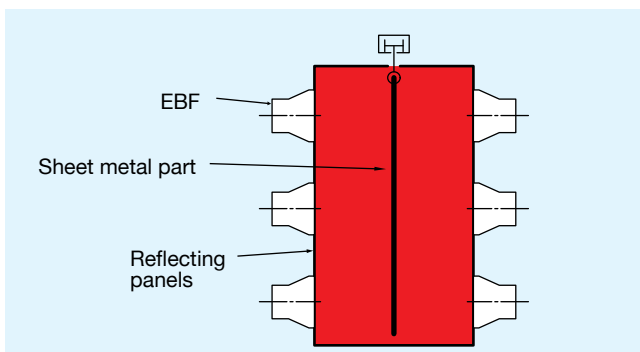

Figure 11: Radiation tunnel with several EBF systems

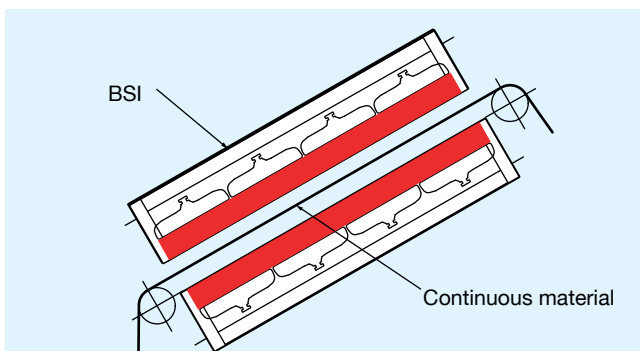

Figure 12: Heating a continuous material using 2 BSI systems

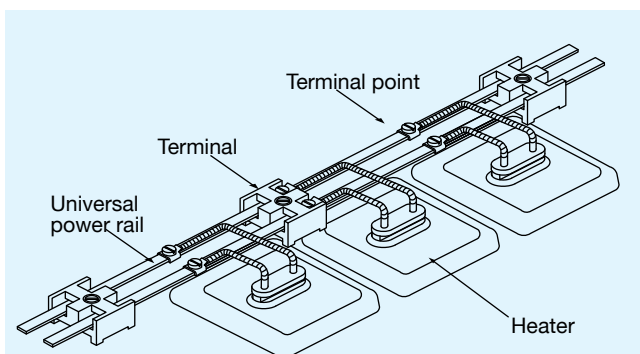

Figure 13: Rail wiring

When planning an infrared heating plant or system, it is the properties of the material to be heated, which primarily determine the power and treatment time required. The easiest and most reliable way to determine the data concerned is to carry out a trial. We are always pleased to provide planning advice and if you wish can carry out heating trials for you.

The choice of heater initially depends on the geometric circumstances of the heating task. The HTS series is the best choice for the heater type. The integrated thermal insulation, the fast thermal performance and the ability to adjust the power via integrated thermocouples offer users optimum possibilities. If fast clock times or high material temperatures are required, the HSR and HLS series can be used. If a low overall height is required, SFH heaters can be used.

For systems, the choice is between BSI, EBF and REF. The EBF system is particularly advantageous for solving line-shaped heating tasks and for building infrared heating areas with variable geometries (cf. Figure 10). The BSI system is ideal for building even or large IR heating areas. All systems can be used with both a one-sided and a double-sided arrangement. If two heating areas radiate each other, for safety reasons special attention must be paid to compliance with the maximum permissible heater temperatures.

In operation, the EBF and the BSI system can reach housing temperatures of up to around 250 °C. Therefore, the user must plan in design measures to prevent contact with the hot metal parts. Elstein infrared emitters do not have any dazzling effects. However we recommend screening off the sides of the heating areas with polished aluminium or stainless steel plates. This prevents unnecessary heating of parts outside the actual oven and improves energy utilisation. For stability reasons, EBF and BSI systems must not have any additional thermal insulation.

When designing the industrial ovens, particular attention must be paid to ensuring all parts can thermally expand. Large, stiff constructions are therefore disadvantageous. In this context the wiring material is also important. Copper cables can only be used for individual heaters with a low power. The standard are cables made from nickel with heat resistant insulation or rail wirings.

Radiation Distribution

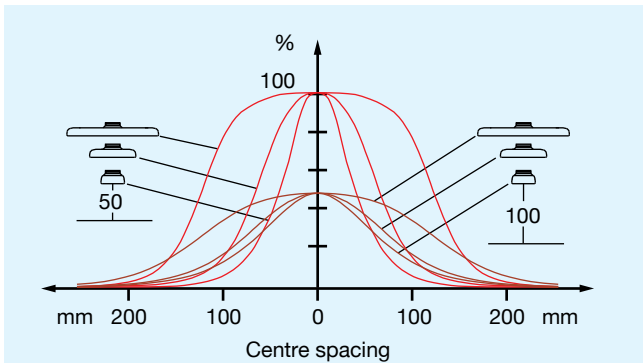

Figure 14: Spatial radiation distribution

Elstein infrared emitters are produced with all kinds of different dimensions and geometries. They are available with round, long, square, rectangular and even with hemisphere shapes. The spatial distribution of the diffuse energy radiated in all directions depends on the outer shape. Figure 14 shows the radiation distributions for two spacings of Elstein HTS/1, HTS/2 and HTS/4. Similar distributions also result for the other models. The intensity is determined by the respective surface temperature. At this point, please note that the curved shape of the FSR does not have any focussing effect with respect to the radiation.

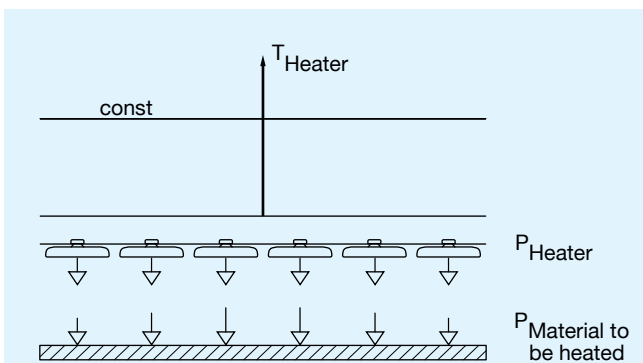

Figure 15: Power at the material to be heated with constant heater power

In plants with a large number of heaters, the radiation distributions of all the heaters overlap. If, for example, several heaters with the same power output are installed next to each other in a machine, there is an increase in power in the middle of the material to be heated, which is mostly unwanted (Figure 15). For uniform power density on the material to be heated, the heaters near the edge must be run with higher power or a higher temperature than the middle heaters (Figure 16).

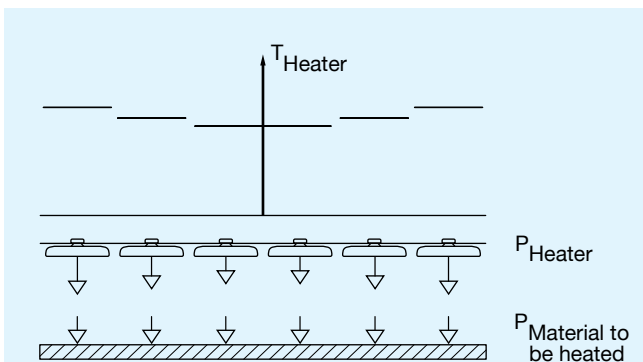

Figure 16: Power at the material to be heated with adjusted heater power

The small design of Elstein infrared emitters enables the user to realise very different radiation distributions on the material to be heated. As radiation energy occurring at a point is the sum of the energy from all the heaters it is sometimes difficult to radiate narrow areas with a particularly intensive or weak radiation. In these cases considerable improvements can be achieved by using shiny metallic reflector plates or shutters. Figure 17 shows examples of possible designs.

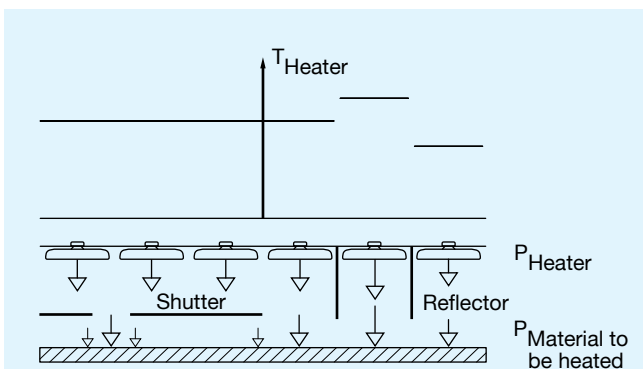

Figure 17: Power adjustment with reflector and shutter

One question often asked is whether additional thermal insulation is needed on the back side of the heaters. This thermal insulation only has a useful effect if the requirements for the uniformity of the radiation distribution on the material to be heated are low. The thermal insulation causes heating of the inner heaters by the outer heaters of a heating area. In the most unfavourable case, the inner heaters can even become superfluous. The majority of the radiation areas are therefore not insulated. In addition, the modern HTS, SHTS and HSR series heaters already have integrated thermal insulation, which does not usually require any additional insulation.

Performance

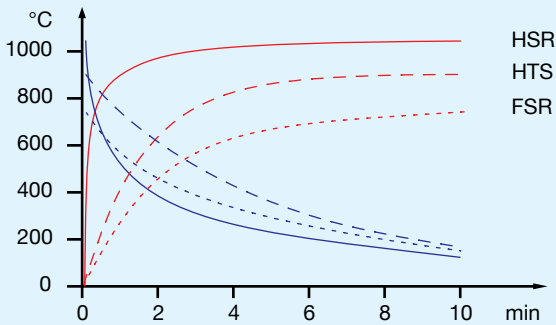

Figure 18: Heating-up and cooling performance

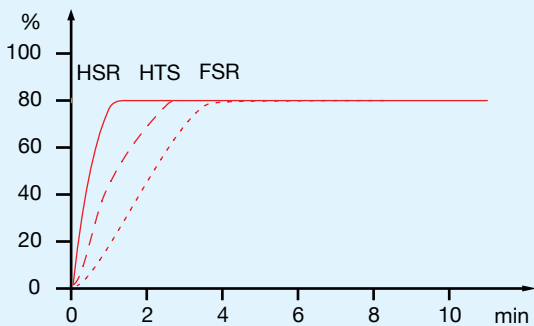

Figure 19: Power in controlled operation

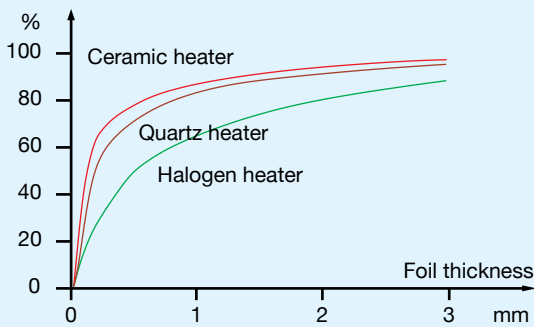

Figure 20: Absorption in transparent foils

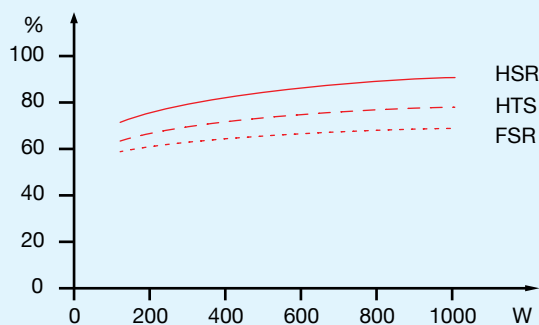

Figure 21: Efficiencies dependent on the power

Elstein infrared emitters differ in their mechanical structure. For example, the HTS series heaters have integrated thermal insulation materials, so that compared to the FSR series heaters, considerably reduced heating-up and cooling times are achieved (Figure 18). With the HSR series heaters the time performance was improved again by a factor of 3.

In this context, please note that the heating-up and cooling performance of an infrared heater can be more easily judged with the heat sensitivity of the skin rather than with the eye. For example, if a halogen spotlight is switched off, the light goes off in a flash. But the hot glass tube continues to dissipate its stored heat to surrounding area for several minutes in the form of infrared radiation.

Infrared radiation is reflected, transmitted and absorbed. Depending on the used IR-radiation source and the properties of the material to be heated the three effects arise in different proportions. The wanted effect, which heats the material is the absorption so that this part of radiation should be as high as possible. High parts of reflection and transmission cause a minor efficiency of the heater. Figure 20 shows an example for three different radiation sources heating a transparent foil: the long-wave infrared radiation of the ceramic IR-heater has the highest efficiency.

The efficiency of Elstein infrared emitters can reach values over 80 % in radiation areas. Figure 21 shows the typical curves for various panel heaters. You can see that the HTS and FSR heaters achieve very good efficiency values even at lower heater powers. The HTS is clearly better than the FSR, thanks to its internal thermal insulation. The best efficiencies are achieved by the HSR heaters because due to their special design they transfer the energy supplied almost without losses as infrared radiation to the material to be heated.

When using Elstein infrared emitters, the limit temperatures given on each heater must be noted and observed. If it is exceeded, the ceramic and the heating conductor can be damaged. Equally, when installing the heaters ensure that the heaters are protected against knocks, impact, and moisture when cold. Due to the fixed installation of the heating coil, the heaters can be operated in any position.

Power Adjustment

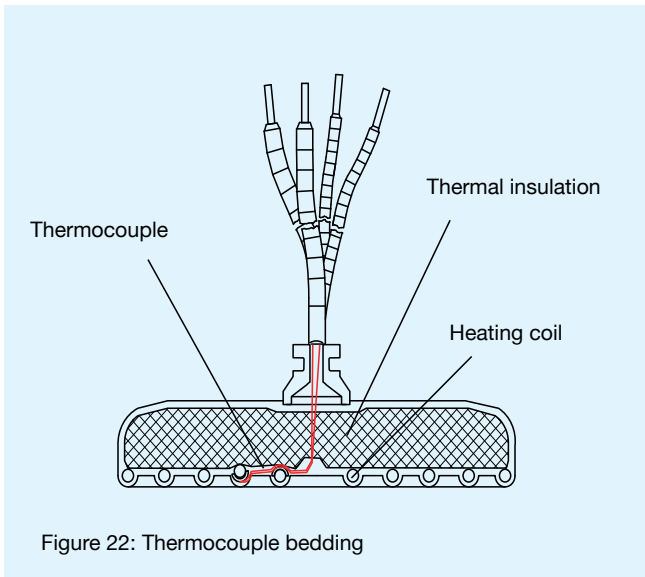

Figure 22: Thermocouple bedding

Elstein infrared emitters are available with varying power levels. The HTS for example has power levels ranging from 250 W to 1000 W. In practice however powers different to these are mostly required. There are three ways of adjusting the heater power to the power requirements of the material to be heated. The most simple way is to change the distance between the heater and the material to be heated. This is only recommended if individual heaters are used. The second way is power control, for example using proprietary dimmers, like those used for lighting purposes.

The third and best way is to adjust the power via temperature control using heaters with an integrated thermocouple. In Elstein's infrared emitters with thermocouple, the thermocouple is located between the radiating surface and the heating coil (Figure 22).

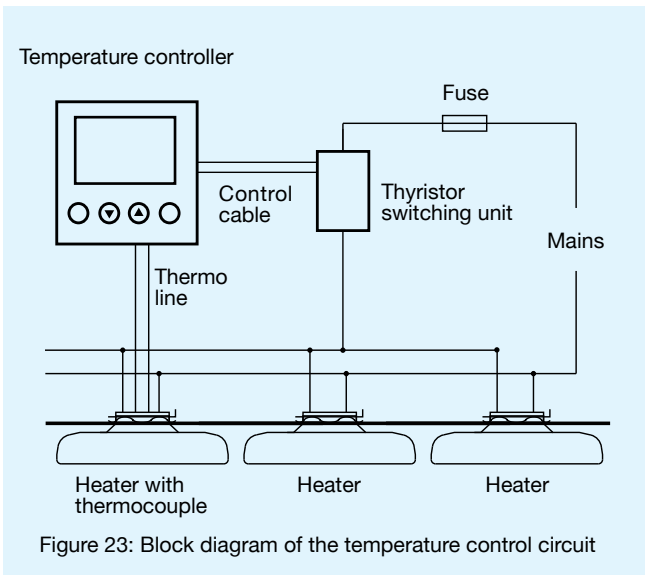

Figure 23: Block diagram of the temperature control circuit

The thermocouple signal is passed via a special thermo line, for example to the input of the Elstein TRD 1 digital temperature controller (Figure 23). The temperature controller switches individual or whole groups of heaters on and off with the help of one or several Elstein TSE thyristor switching units. An average power sets in at the heaters, depending on the length of time they are switched on. An URG super-agile fuse is fitted upstream of the thyristor switching units to protect them against short circuits.

This method enables compliance with the prescribed heater temperature with an accuracy of one degree and thus enables the production conditions to be reproduced. It can also be modified so that the temperature of the material to be heated is measured. However, this requires reliable recording of the temperature of the material to be heated. In most cases it suffices to control the heater temperature.

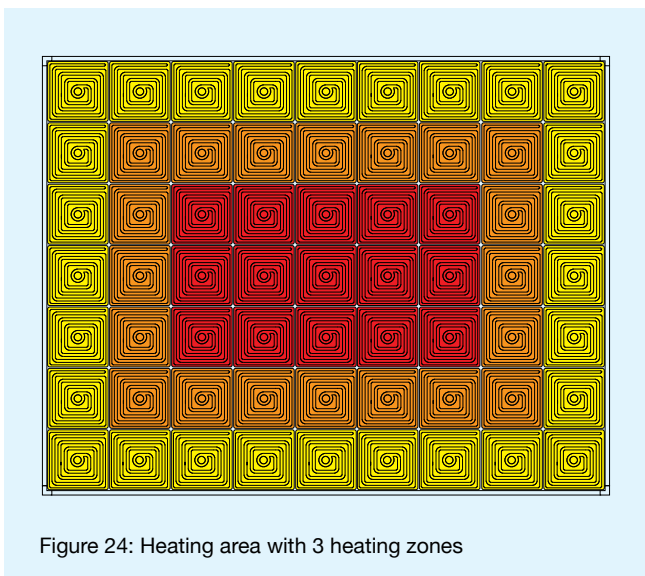

Figure 24: Heating area with 3 heating zones

By using several controllers, zones can be formed in the heating areas, for example, to specifically heat certain areas of the product more strongly or weakly. Annular heating zones are frequently realised for large heating areas in order to uniformly heat up the material to be heated from the boundary area through to the middle (Figure 24).

Special programmable controls can also be used instead of a controller. Here it must be noted that the inputs for the thermocouples must be floating.

General Information

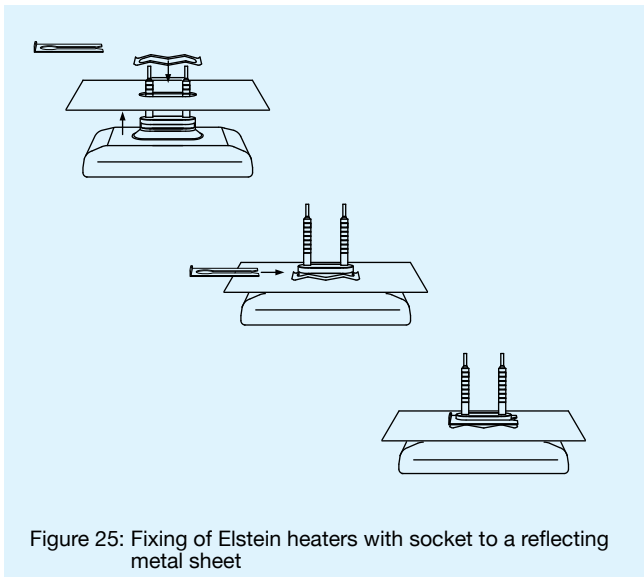

Figure 25: Fixing of Elstein heaters with socket to a reflecting metal sheet

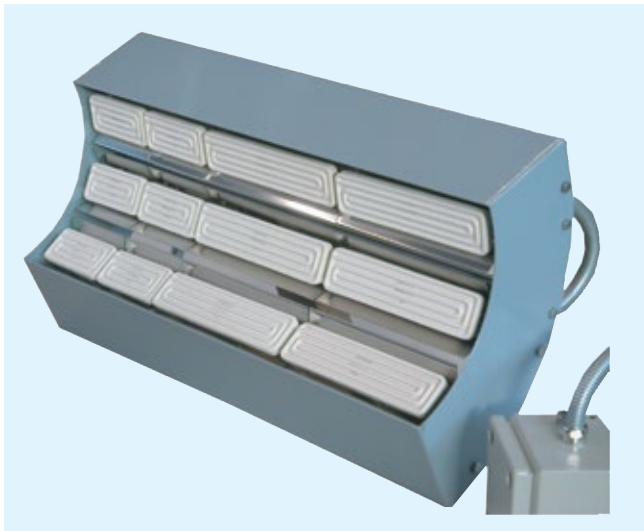

Figure 26: Roller heating

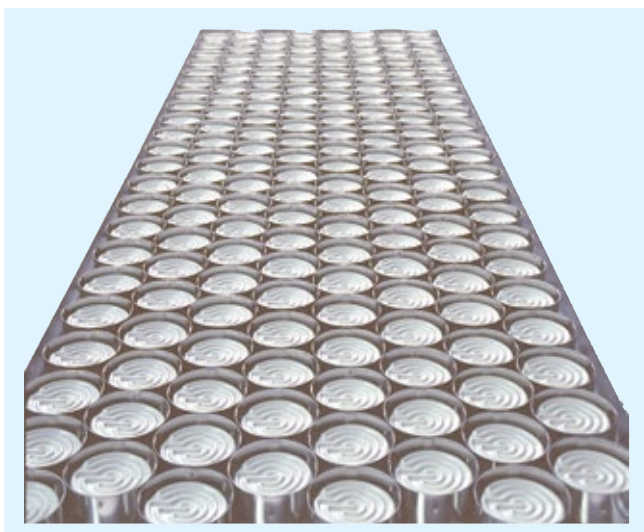

Figure 27: Heating area to heat up the bottoms of bottles

Many Elstein infrared emitters have a standard socket, with which they can be easily mounted on a reflector sheet (Figure 25).

The heaters' leads have defined standard lengths, but it is also possible to manufacture heaters with longer leads. The length can be chosen almost at will but it should not exceed 400 mm, because then the electrical safety is no longer guaranteed. For lengths over 400 mm our manufacturer's liability expires.

Due to the thermal expansion, when designing plant or systems you must ensure that the infrared heaters have adequate space. In general, a distance of 3 mm should be available between adjacent infrared heaters. The installed dimensions to be observed are given in the data sheets for Elstein infrared emitters.

The service life of infrared heaters depends on the use conditions and the heater operating temperatures. The following table contains details of the service life of Elstein heaters (230 V) when operated under normal conditions:

at 400 °C	approx. 20.000 hours	(e.g. FSR 250 W)
at 700 °C	approx. 10.000 hours	(e.g. FSR 1000 W)
at 900 °C	approx. 8.000 hours	(e.g. HTS 1000 W)
at 1100 °C	approx. 2.000 hours	(e.g. HLS 750 W)

Unfavourable use conditions or incorrect heater use can reduce the service life. Details of this are given in the safety instructions of this document. Negative influencing factors with respect to service life are, for example, chemical contaminations (chlorine, fluorine, hydrofluoric acid, caustic soda, nitrogen or peroxide), excessive mechanical loads or stresses and overheating.

As a standard Elstein infrared emitters are designed for 230 V. Sometimes however, customers want or need to use other operating voltages. Most Elstein infrared emitters can also be supplied with other voltages. Operating voltages above 270 V, however require thinner heating conductors than usual. The consequence is a lower durability under the same operating conditions.

Except for under atmospheric conditions, Elstein infrared emitters are also used in vacuums. They are however not available in an explosion-proof version. Nevertheless, there are ways to reach solutions, which enable Elstein infrared emitters to be used. We will be pleased to advise you if you have corresponding heating tasks.

Safety Instructions

Improper use of electrically operated infrared heaters can, under unfavourable circumstances, result in fire or electric shock. This in turn can cause personal injuries and/or damage or even destruction of machines. For this reason the system builder and user must check whether the heaters are suitable for the respective application. The safety aspect must always be taken into account when selecting, installing and using the heaters. Our technical consultants will be pleased to answer any questions you may have concerning this issue.

Operating and installation instructions are available on request and our homepage (www.elstein.com). These must be read and understood before putting the corresponding product into service. In the event of damage caused by failure to follow the instructions, the warranty claims and our liability for resulting consequential damages expire. The installation, electrical connection and putting into service must be carried out by appropriately qualified personnel. The national safety requirements of the country, in which the products are used, must be taken into account. These are, amongst other things, IEC, EN, VDE, UL and NEC standards.

The following points must be noted when using our products (heaters and accessories):

Installation/assembly of the infrared heaters

- 1) Do not install until you have read and understood the installation and safety instructions first.
- 2) Replacement of heaters and accessories may only be carried out after disconnecting all the system's poles from the electrical system.
- 3) The heaters must be installed at a safe distance from materials and living things to ensure no fire or damage can ensue.
- 4) Heaters with E27 screwed bases may only be used in porcelain sockets or metal sockets with a porcelain insert.

Operating the infrared heaters

- 5) The heaters must be operated so that they cannot be touched by the operating personnel or users. If necessary, warnings are to be attached in the personnel or user's language.
- 6) The heaters may only be operated up to the maximum allowable temperature stamped on the heaters.
- 7) It is advisable to operate the heaters with a temperature controller (thermostat) to avoid impermissibly high temperatures (see page 10 "Power adjustment").

Heaters with a power from 600 W should always be installed with controlled operation. Heater type HLS must always be used with temperature control.

8) Use of a power control is possible. However, for safety reasons, preference is to be given to temperature control with the help of thermocouple heaters.

9) It must be taken into account that when materials containing solvents are heated (paints, glues, etc.) they emit solvent vapours. The vapours can form a combustible air - gas mixture. This also applies to a high level of dust in air. Therefore, for example, the Explosion Protection Directive (Article 501 National Electrical Code NEC in USA) must be taken into account.

10) After they are switched off the heaters still have residual heat. This can cause burns if the heaters are touched. Sensitive heated materials or objects can be damaged.

Handling ceramic infrared heaters

- 11) The heaters must be protected against shock, impact and damp.
- 12) If heaters come into contact with water, e.g. when cleaning the system, they must be immediately dried by briefly heating them.
- 13) Damaged heaters must be replaced immediately.

Notes on equipment and system building

14) The electrical and mechanical accessories for setting up an infrared radiation system must be designed so that they withstand the thermal, electrical and mechanical stresses.

15) It is always advisable to install equipment which switches off the infrared heaters, e.g. in the event of faults in the system. Such equipment may be absolutely necessary where the heaters are used to heat sensitive or easily combustible materials or living beings. The decision and responsibility for their installation lies with the system builder.

16) The system builder must note and observe the relevant standards and regulations for installation and operation of the heaters depending on their use.

This especially applies to equipment and systems used for heating people or animals (for example, medical, therapeutic or wellness equipment). The manufacturer of the complete equipment/appliance is responsible for compliance with the regulations.

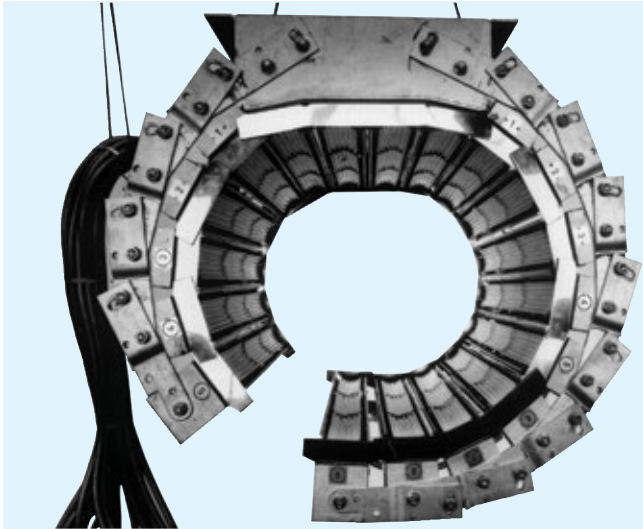

Figure 28: Heating head for heating GRP pipes



Figure 29: Heat therapy appliance

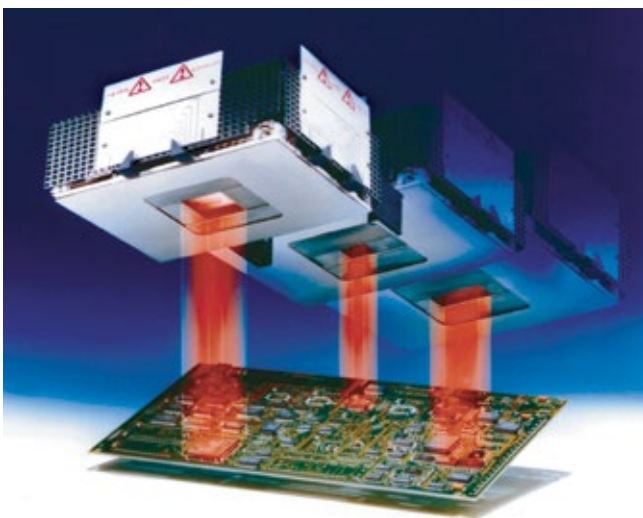

Figure 30: SMD soldering head for printed circuit board repairs

For decades, Elstein infrared emitters have been proven heating elements for solving heating tasks. They are available in various designs, models as well as power levels and therefore enable users, to optimally adjust them to the heating task.

Elstein infrared emitters and IR-systems have the following advantages:

1. High emission capacity
2. Robustness
3. Long durability
4. Simple to control with degree accuracy
5. High surface rating
6. Standardised dimensions and powers
7. Modular structure
8. Scale free surfaces

These advantages have helped to guarantee customer satisfaction over decades and guarantee this in future tasks too.

This brochure represents the major part of our know how and our experiences. However it cannot and shall not replace expert advice. Please contact us if you require further help in solving your heating task.

On the following pages please find further information and technical data about our products.



Figure 31: Elstein FSR series

Elstein FSR panel heaters are ceramic infrared heaters, which are designed for operating temperatures up to 720 °C. Surface ratings of up to 64 kW/m² can be installed.

FSR series heaters are made using a full-pour casting ceramic process and are characterised by their concave design. Due to the design of this type, there is a space between the heater and mounting plate, which reduces the heat absorbed by the wiring space.

FSR panel heaters can be used universally and are suitable for assembling radiation areas with any geometry required. They are available in three designs and cover the power range from 60 W to 1000 W.

With its FSR panel heaters, the company Elstein-Werk has been setting design, type, power and quality standards, recognised worldwide since 1952, for ceramic infrared panel heaters.

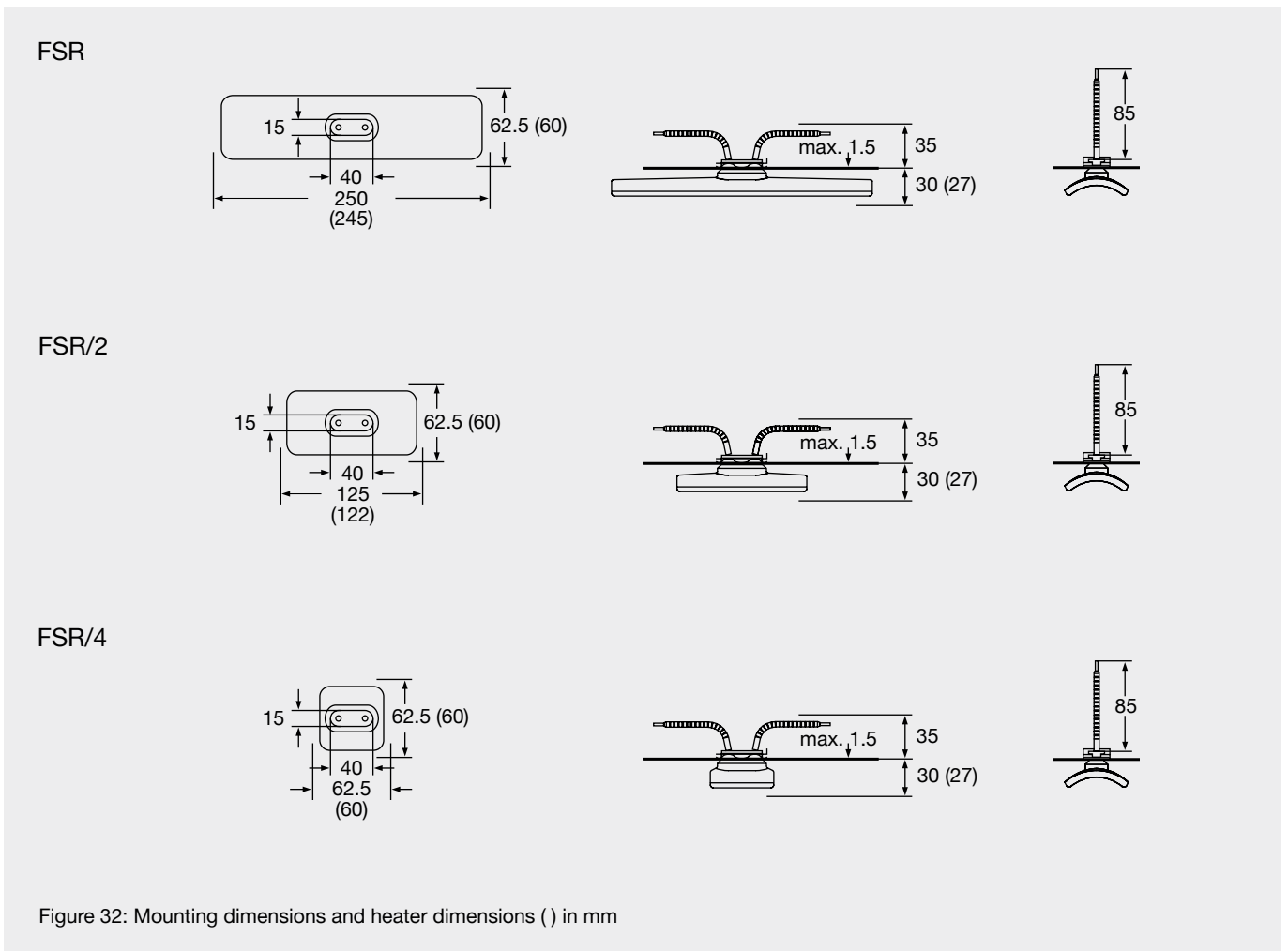

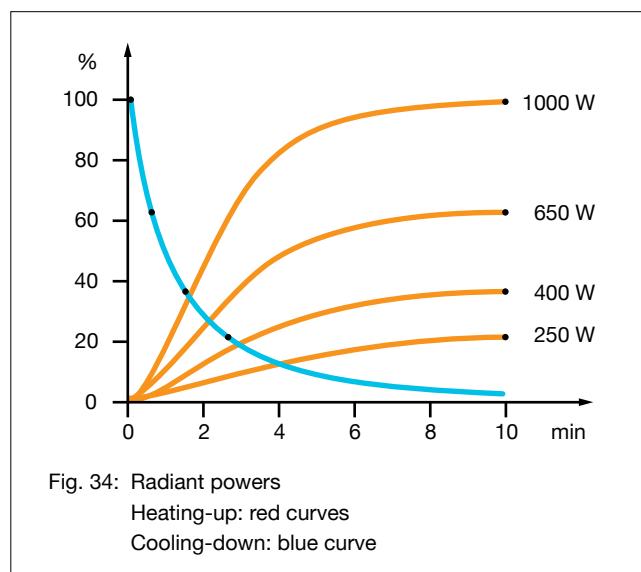
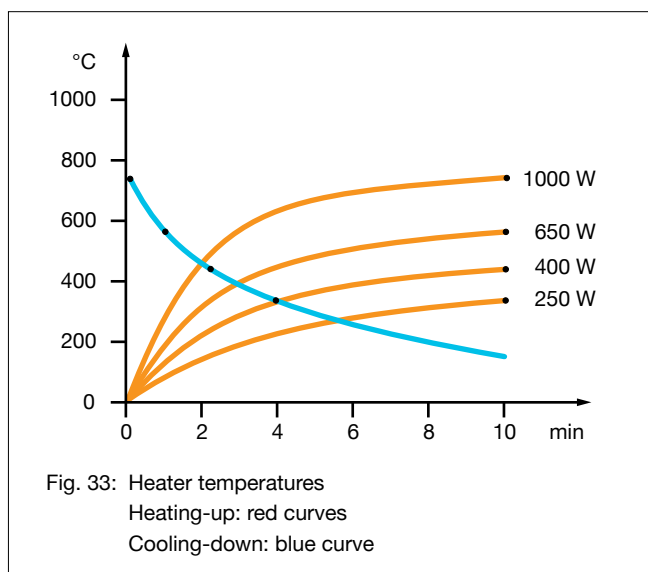

Type, weight, wattage	FSR	220 g	250	400	650	1000	W
	FSR/2	125 g	125	200	325	500	W
	FSR/4	75 g	60	100	200	250	W
Installable surface rating			16.0	25.6	41.6	64.0	kW/m ²
Typical operating temperature			to 400	to 500	to 620	to 720	°C
Maximum permissible temperature			750	750	750	750	°C
Wavelength range			2 - 10				µm

<p>Standard design</p> <p>Operating voltage 230 V Ceramic full-pour casting Leads 85 mm Elstein standard socket Mounting set</p>	<p>Thermocouple heaters</p> <p>Designation T-FSR, T-FSR/2, T-FSR/4 Integrated thermocouple Type K (NiCr-Ni) TC leads 100 mm</p> 	<p>Variants</p> <p>Special wattages Special voltages Extended leads Leads with ring terminals Coloured glazes</p>
---------------------------------------------------------------------------------------------------------------------------------------------------------	----------------------------------------------------------------------------------------------------------------------------------------------------------------------------------------------------------------------------------------	------------------------------------------------------------------------------------------------------------------------------------------

The power can be controlled using thermocouple heaters together with TRD 1 temperature controllers, TSE thyristor switching units and other accessories.

IR radiation areas can be assembled using REO reflectors, REF construction sets, EBF and EBI construction elements as well as MBO mounting sheets.

The national safety regulations must be complied with for the respective application, for example, the IEC or EN standard 60519-1, Safety in electrical heating installations.

Our instructions for mounting, operation and safety must be observed.

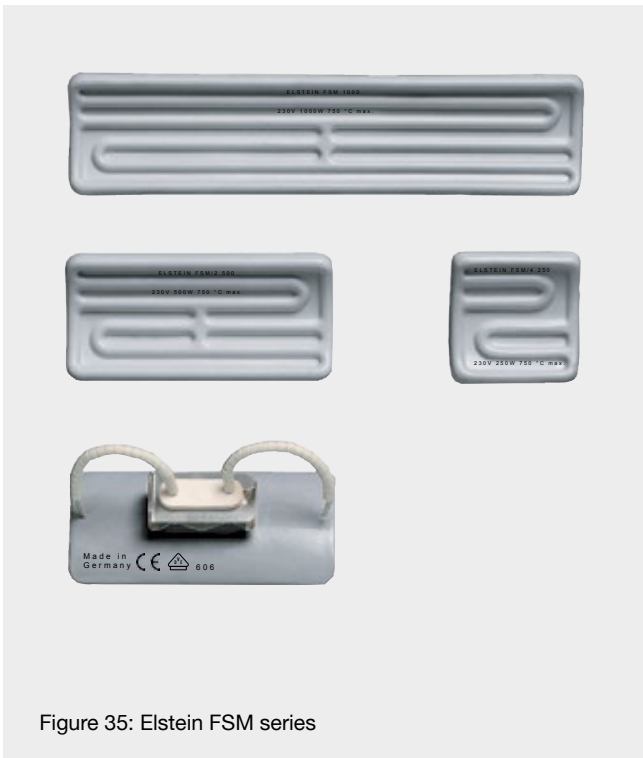

Figure 35: Elstein FSM series

Elstein MaxLife FSM panel heaters are ceramic infrared heaters, which are designed for operating temperatures up to 720 °C. Surface ratings of up to 64 kW/m² can be installed.

The durability of MaxLife panel heaters FSM has been maximized. Thus they are usable for 35000 hours and more when operated correctly and under normal conditions.

Due to this significantly longer service life of MaxLife heaters the cost for heater exchange is reduced. Thus there are much lower cost per operating hour.

A guarantee of operation about 20 000 hours or three years beginning from the manufacturing date exists for heaters of the FSM series with 230 V on the basis of correct heater use and normal operating conditions.

Elstein MaxLife panel heaters FSM are available in three designs and cover the power range from 60 W to 1000 W.

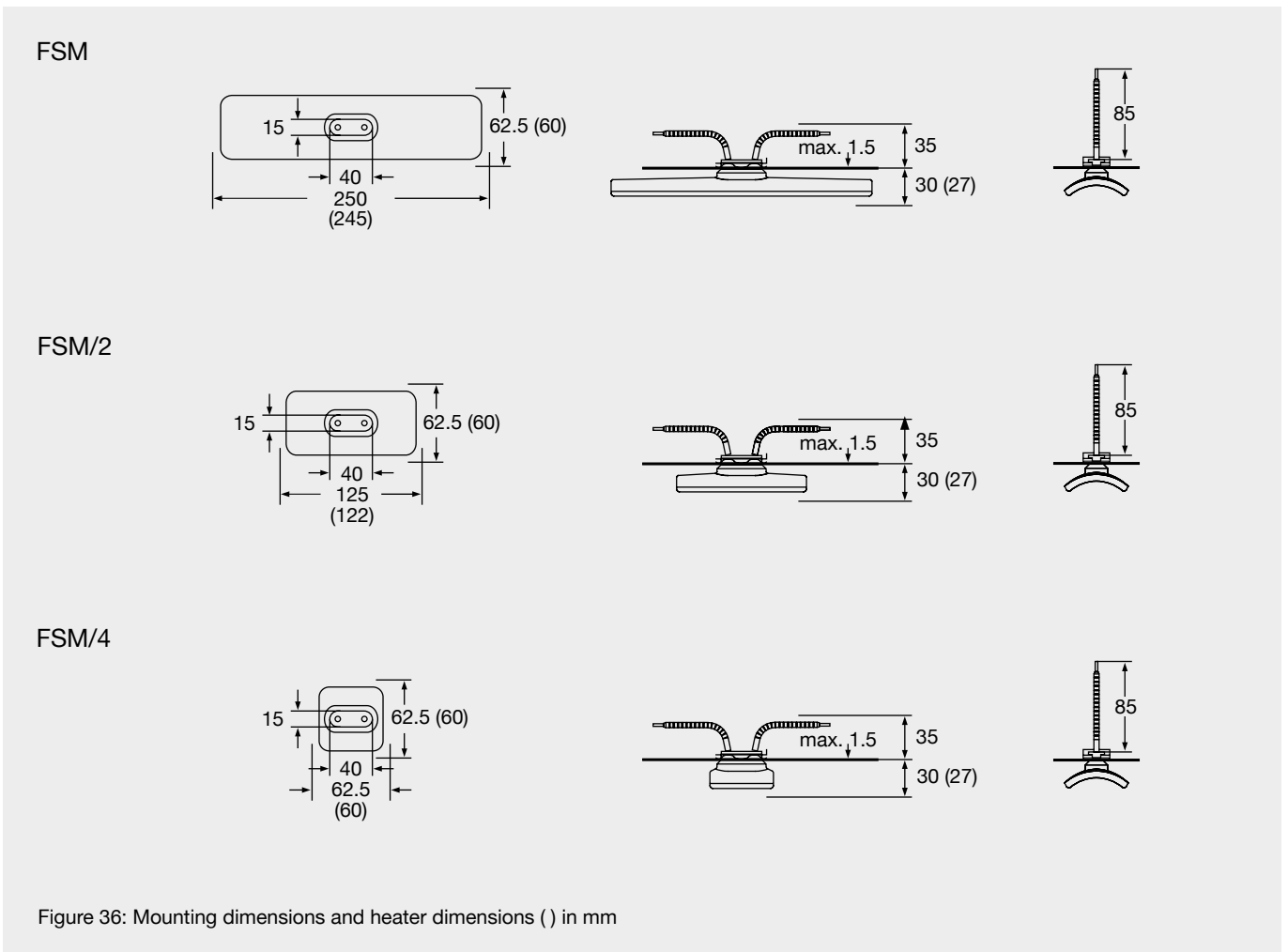
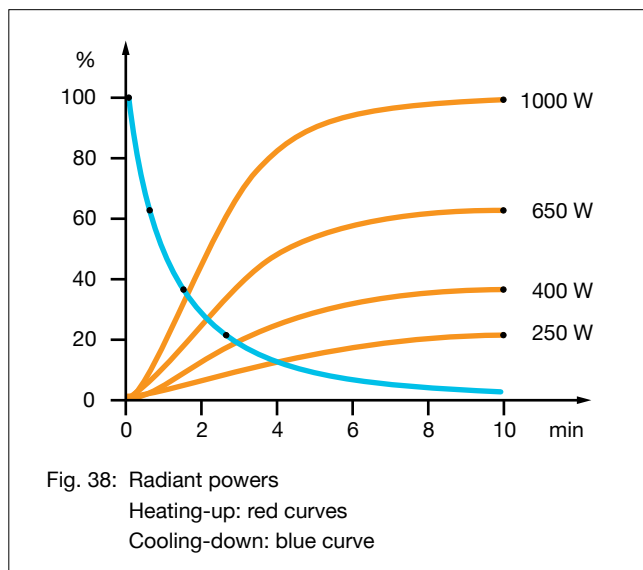
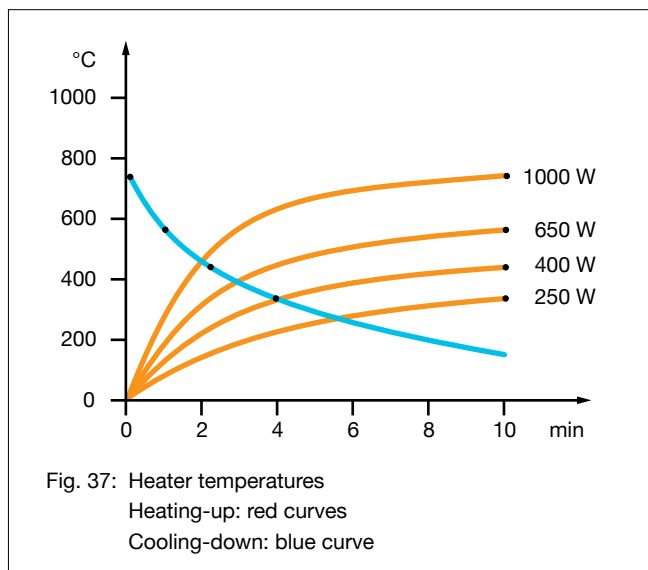
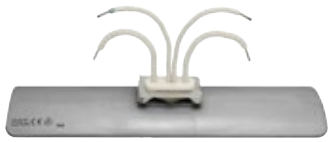

Figure 36: Mounting dimensions and heater dimensions () in mm



Type, weight, wattage	FSM	220 g	250	400	650	1000	W
	FSM/2	125 g	125	200	325	500	W
	FSM/4	75 g	60	100	200	250	W
Installable surface rating			16.0	25.6	41.6	64.0	kW/m ²
Typical operating temperature			to 400	to 500	to 620	to 720	°C
Maximum permissible temperature			750	750	750	750	°C
Wavelength range			2 - 10				µm

<p>Standard design</p> <p>Operating voltage 230 V Ceramic full-pour casting Leads 85 mm Elstein standard socket Mounting set Grey glaze</p>	<p>Thermocouple heaters</p> <p>Designation T-FSM, T-FSM/2, T-FSM/4 Integrated thermocouple Type K (NiCr-Ni) TC leads 100 mm</p> 	<p>Variants</p> <p>Special wattages Special voltages Extended leads Leads with ring terminals</p>
------------------------------------------------------------------------------------------------------------------------------------------------------------------------	----------------------------------------------------------------------------------------------------------------------------------------------------------------------------------------------------------------------------------------	----------------------------------------------------------------------------------------------------------------------

The power can be controlled using thermocouple heaters together with TRD 1 temperature controllers, TSE thyristor switching units and other accessories.

IR radiation areas can be assembled using REO reflectors, REF construction sets, EBF and EBI construction elements as well as MBO mounting sheets.

The national safety regulations must be complied with for the respective application, for example, the IEC or EN standard 60519-1, Safety in electrical heating installations.

Our instructions for mounting, operation and safety must be observed.



Figure 39: Elstein HTS series

Elstein HTS high temperature heaters are ceramic infrared panel heaters, which can be used for operating temperatures up to 860 °C and surface ratings up to 64 kW/m².

HTS series heaters are produced using a hollow-casting ceramic process and are filled with thermal insulation material. This improves the radiant power output to the material to be heated.

Furthermore, there is a significant reduction in heat dissipated in the wiring space, so that additional insulation of the heating area is usually not required.

Compared with IR heaters, which are produced using full-poured casting processes, HTS heaters have a considerably reduced heating-up time and, depending on the type of application, enable energy savings of up to 25 %.

Elstein HTS high temperature heaters are available in four designs and cover the power range from 60 W to 1000 W.

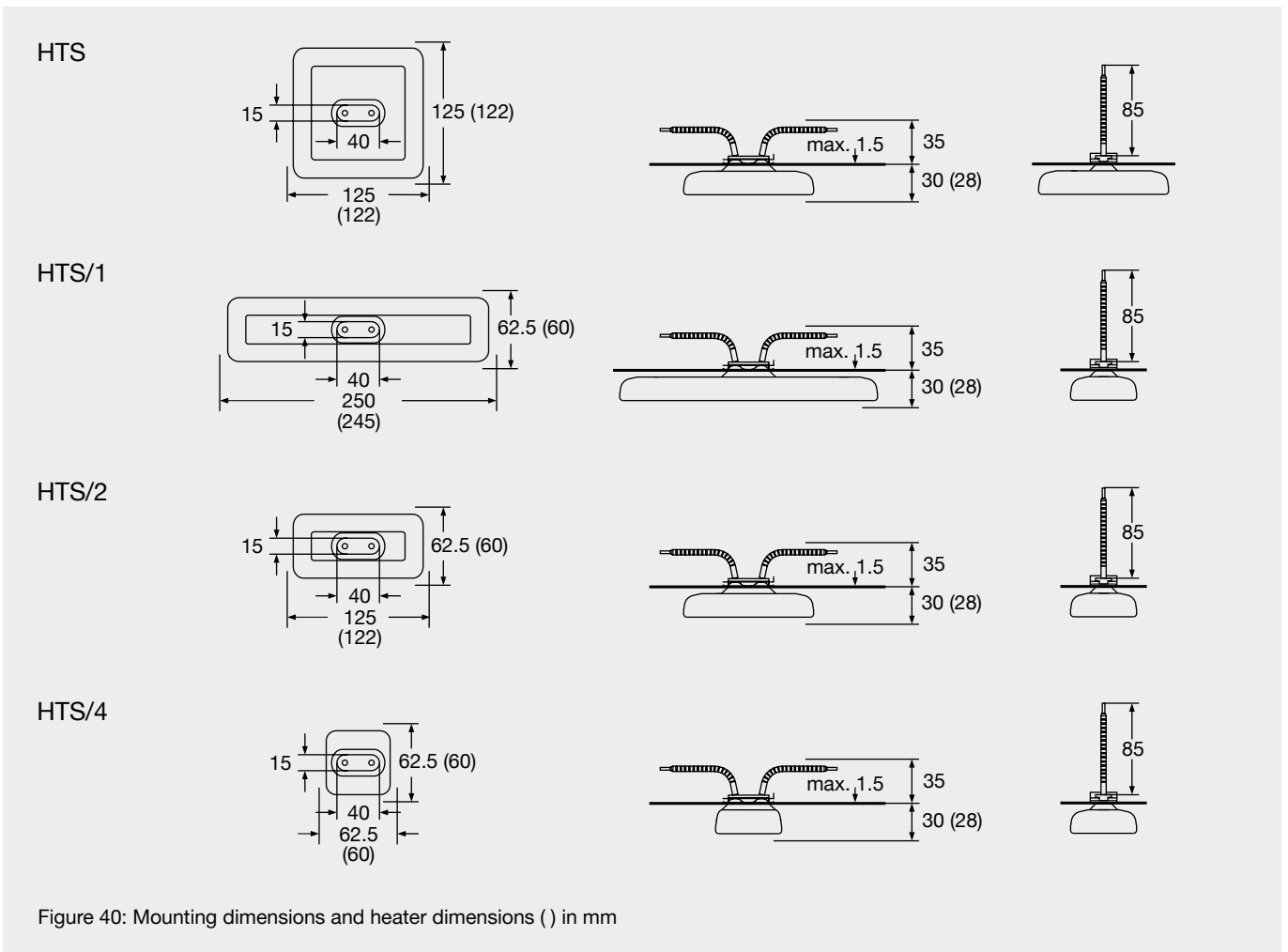

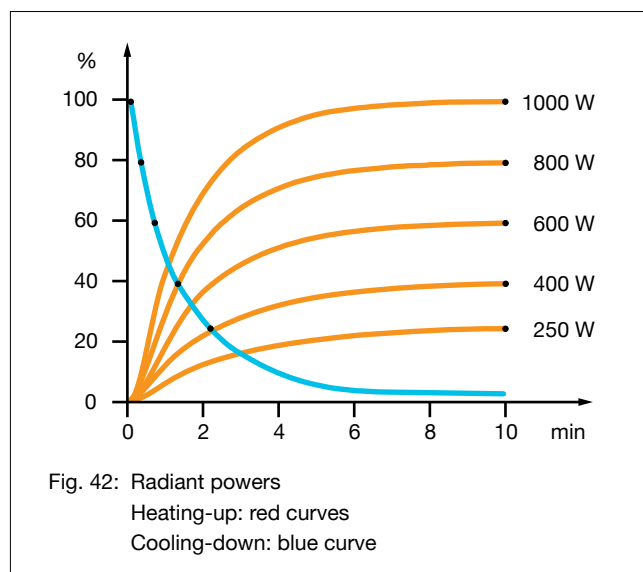
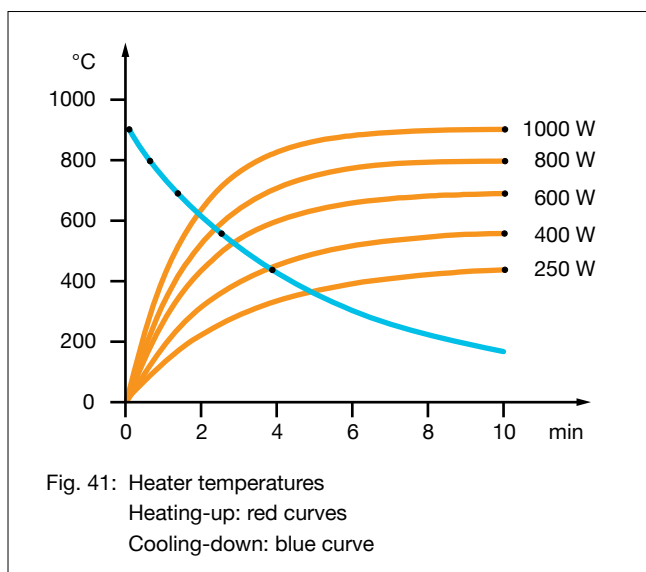

Type, weight, wattage	HTS/1, HTS	220 g	250	400	600	800	1000	W
	HTS/2	125 g	125	200	300	400	500	W
	HTS/4	75 g	60	100	150	200	250	W
Installable surface rating			16.0	25.6	38.4	51.2	64.0	kW/m ²
Typical operating temperature			to 450	to 570	to 700	to 810	to 860	°C
Maximum permissible temperature			900	900	900	900	900	°C
Wavelength range			2 - 10					µm

Standard design	Thermocouple heaters	Variants
Operating voltage 230 V Ceramic hollow casting Integrated thermal insulation Leads 85 mm Elstein standard socket Mounting set	Designation T-HTS, T-HTS/1, T-HTS/2, T-HTS/4 Integrated thermocouple Type K (NiCr-Ni) TC leads 100 mm	Special wattages Special voltages Extended leads Leads with ring terminals Coloured glazes

The power can be controlled using thermocouple heaters together with TRD 1 temperature controllers, TSE thyristor switching units and other accessories.

IR radiation areas can be assembled using REO reflectors, REF construction sets, EBF and EBI construction elements, MBO mounting sheets as well as BSH and BSI construction panels.

The national safety regulations must be complied with for the respective application, for example, the IEC or EN standard 60519-1, Safety in electrical heating installations.

Our instructions for mounting, operation and safety must be observed.



Figure 43: Elstein SHTS series

Elstein SHTS super high temperature heaters were developed to increase the previous maximum possible surface rating of ceramic panel heaters from 64 kW/m² to 77 kW/m².

The SHTS heaters, produced using the hollow casting ceramic process, are filled with thermal insulation material and have a special black glaze and a gold-plated back. At an operating temperature of 900 °C, over 75 % of the electrical energy supplied is transferred to the material to be heated as medium to long-wave IR radiation.

SHTS series heaters are therefore particularly suitable for use in plant construction, in which special solutions have to be drawn up for the customer's specific needs and for applications requiring high outputs.

The four designs cover the power range from 300 W to 1200 W and have customary market dimensions. Existing IR equipments can therefore be retrofitted with Elstein SHTS series heaters.

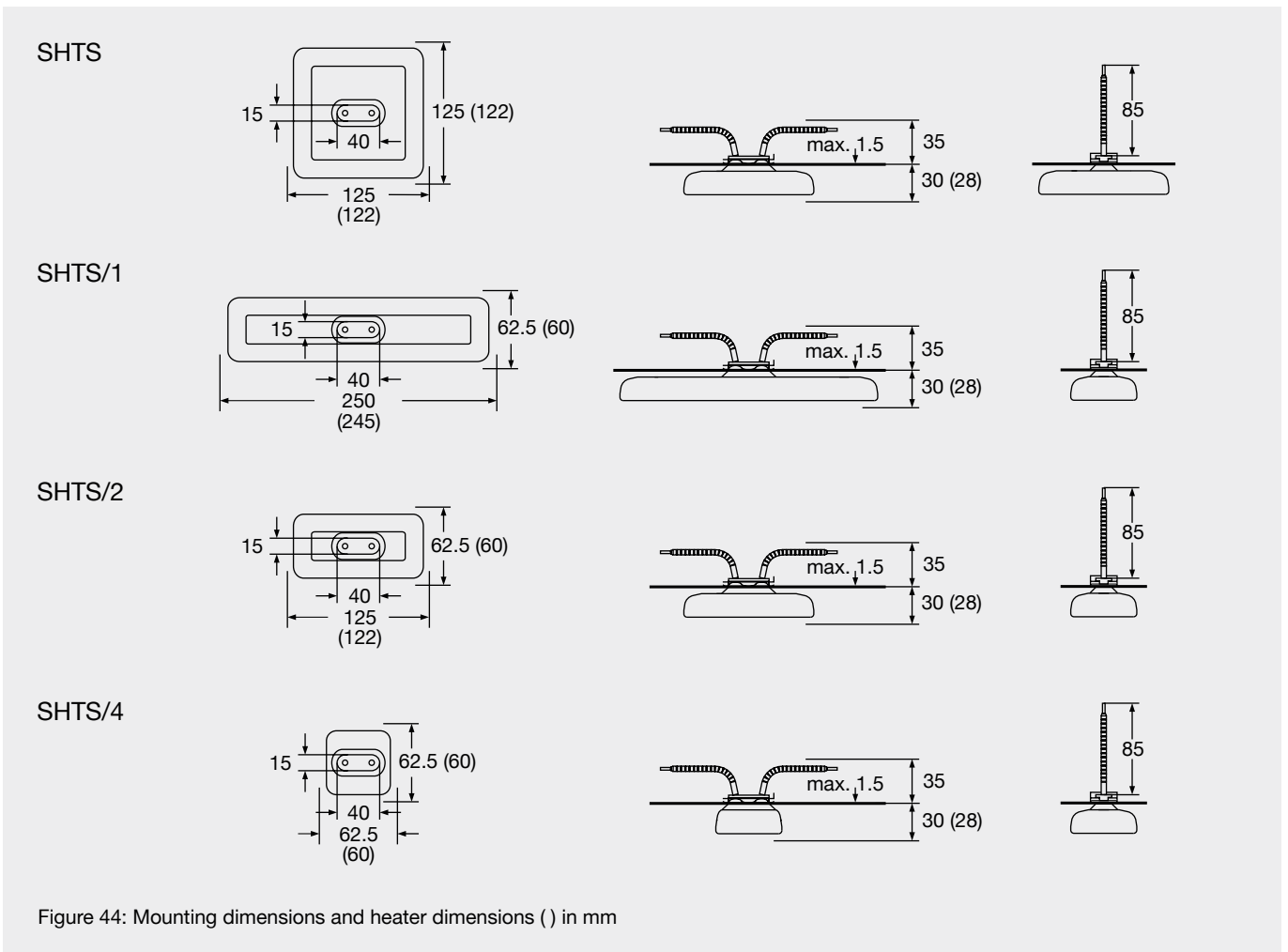
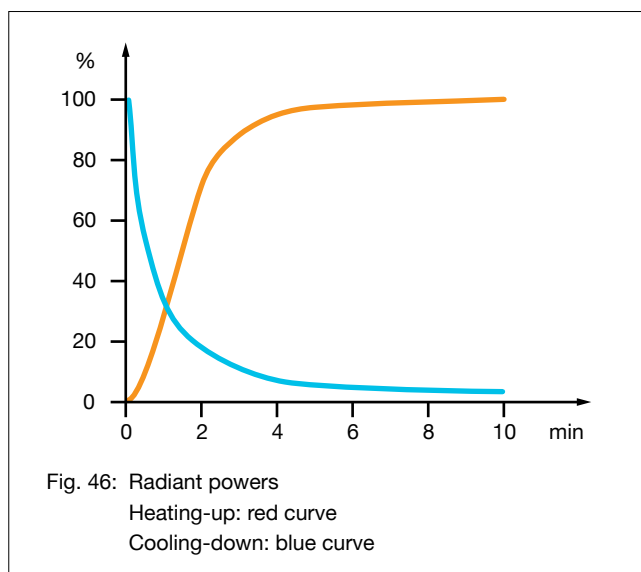
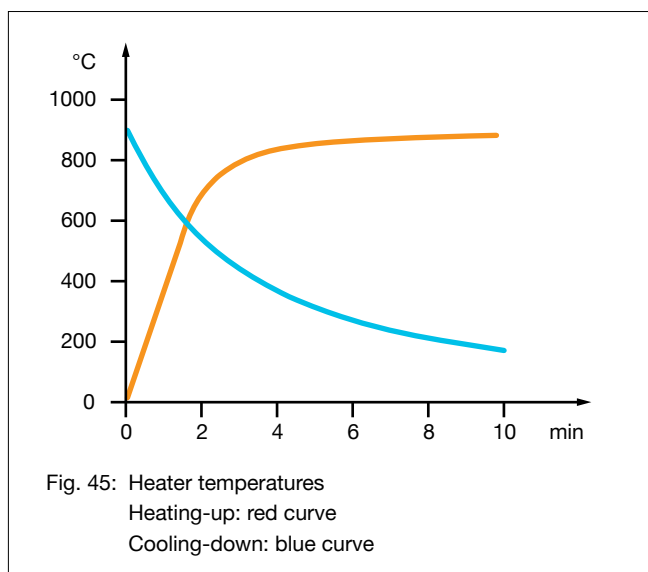

Figure 44: Mounting dimensions and heater dimensions () in mm



Type, weight, wattage	SHTS/1, SHTS	220 g	1200	W
	SHTS/2	125 g	600	W
	SHTS/4	75 g	300	W
Installable surface rating			76.8	kW/m ²
Typical operating temperature			to 860	°C
Maximum permissible temperature			900	°C
Wavelength range			2 - 10	µm

Standard design	Thermocouple heaters	Variants
Operating voltage 230 V Ceramic hollow casting Integrated thermal insulation Leads 85 mm Elstein standard socket Mounting set Special black glaze Gold-plated back	Designation T-SHTS, T-SHTS/1, T-SHTS/2, T-SHTS/4 Integrated thermocouple Type K (NiCr-Ni) TC leads 100 mm	Special wattages Special voltages Extended leads Leads with ring terminals

The power can be controlled using thermocouple heaters together with TRD 1 temperature controllers, TSE thyristor switching units and other accessories.

IR radiation areas can be assembled using REO reflectors, REF construction sets, EBF and EBI construction elements as well as MBO mounting sheets.

The national safety regulations must be complied with for the respective application, for example, the IEC or EN standard 60519-1, Safety in electrical heating installations.

Our instructions for mounting, operation and safety must be observed.



Figure 47: Elstein HSR series

Elstein HSR high speed heaters are quick-reaction ceramic infrared panel heaters, designed for operating temperatures up to 860 °C and surface ratings up to 64 kW/m².

The external characteristics of the HSR heaters is their visible heating coil, which is installed in a ceramic body. This design shortens the heating up and cooling down time up to 65 % as well as a reduced heat transfer to the wiring space.

HSR high speed heaters are particularly suitable for use in clocked production processes, for frequent tool changes or if the temperature has to drop quickly in case of transfer disruptions, in order to prevent damage to the production plant.

Elstein HSR high speed heaters are available in three designs and cover the power range from 125 W to 1000 W.

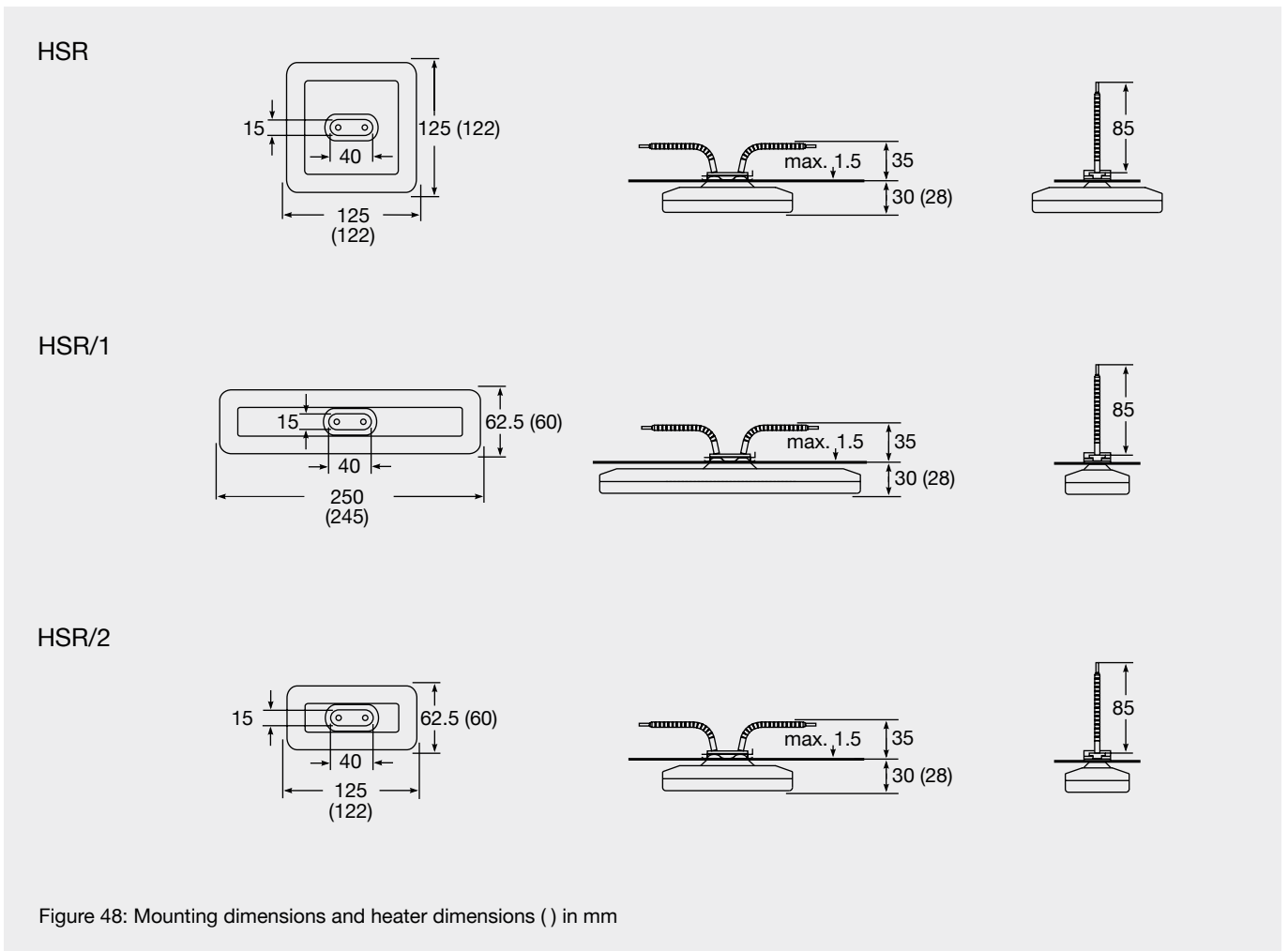

Figure 48: Mounting dimensions and heater dimensions () in mm

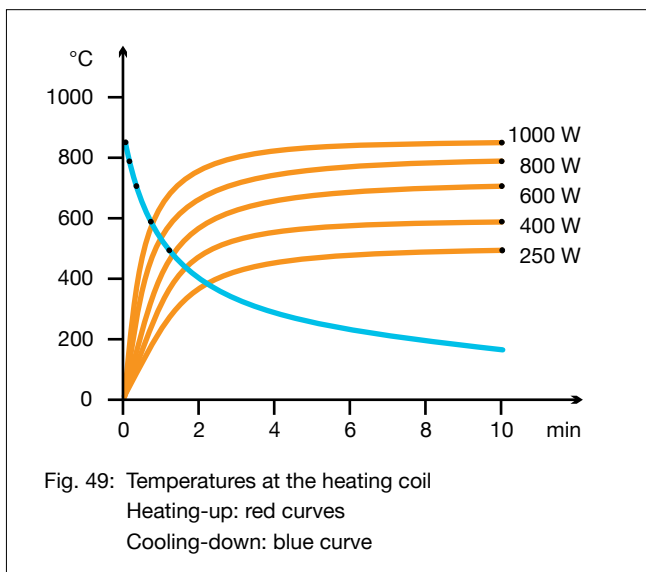

Fig. 49: Temperatures at the heating coil
Heating-up: red curves
Cooling-down: blue curve

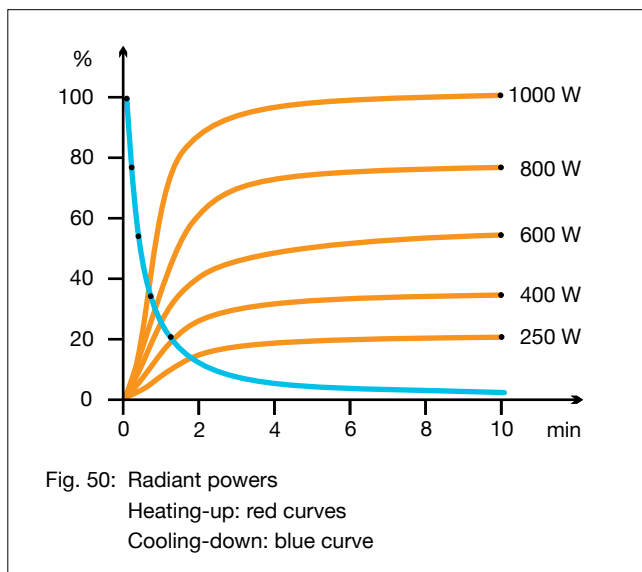



Fig. 50: Radiant powers
Heating-up: red curves
Cooling-down: blue curve

Type, weight, wattage	HSR	220 g	250	400	600	800	1000	W
	HSR/1	220 g	250	400	600	800	1000	W
	HSR/2	125 g	125	200	300	400	500	W
Installable surface rating			16.0	25.6	38.4	51.2	64.0	kW/m ²
Typical operating temperature			to 450	to 570	to 700	to 810	to 860	°C
Maximum permissible temperature			900	900	900	900	900	°C
Wavelength range			2 - 10					µm

<p>Standard design</p> <p>Operating voltage 230 V Ceramic moulding Integrated thermal insulation Leads 85 mm Elstein standard socket Mounting set</p> <p>Information regarding the REACH conformity is available on request.</p>	<p>Thermocouple heaters</p> <p>Designation T-HSR, T-HSR/1, T-HSR/2 Integrated thermocouple Type K (NiCr-Ni) TC leads 100 mm</p> 	<p>Variants</p> <p>Special wattages Special voltages Extended leads Leads with ring terminals</p>
-------------------------------------------------------------------------------------------------------------------------------------------------------------------------------------------------------------------------------------------------------------	----------------------------------------------------------------------------------------------------------------------------------------------------------------------------------------------------------------------------------------	----------------------------------------------------------------------------------------------------------------------

The power can be controlled using thermocouple heaters together with TRD 1 temperature controllers, TSE thyristor switching units and other accessories.

IR radiation areas can be assembled using REO reflectors, REF construction sets, EBF and EBI construction elements, MBO mounting sheets as well as BSH and BSI construction panels.

The national safety regulations must be complied with for the respective application, for example, the IEC or EN standard 60519-1, Safety in electrical heating installations.

Our instructions for mounting, operation and safety must be observed.



Important: The heaters of the HSR series must be installed and operated in a way, which does not enable touching the heaters (risk of injury due to electric shock).



Figure 51: Elstein SFH series

Elstein SFH super flat heaters are ceramic infrared heaters in flat design. They reach operating temperatures up to 800 °C and surface ratings up to 64 kW/m².

The heaters of the SFH series are very suited for applications, which require space-saving installation.

The borders of SFH super flat heaters are used as bearing surface on a metal mounting sheet or reflector. For each heater a corresponding rounded mounting hole is required to place the heaters into them.

When mounting SFH heaters a heat insulation can be added additionally. A temperature resistant insulating material like Elstein THI thermal insulation sheet can be applied on site directly on the back of the heater.

Elstein SFH super flat heaters are available in four designs and cover the power range from 60 W to 1000 W.

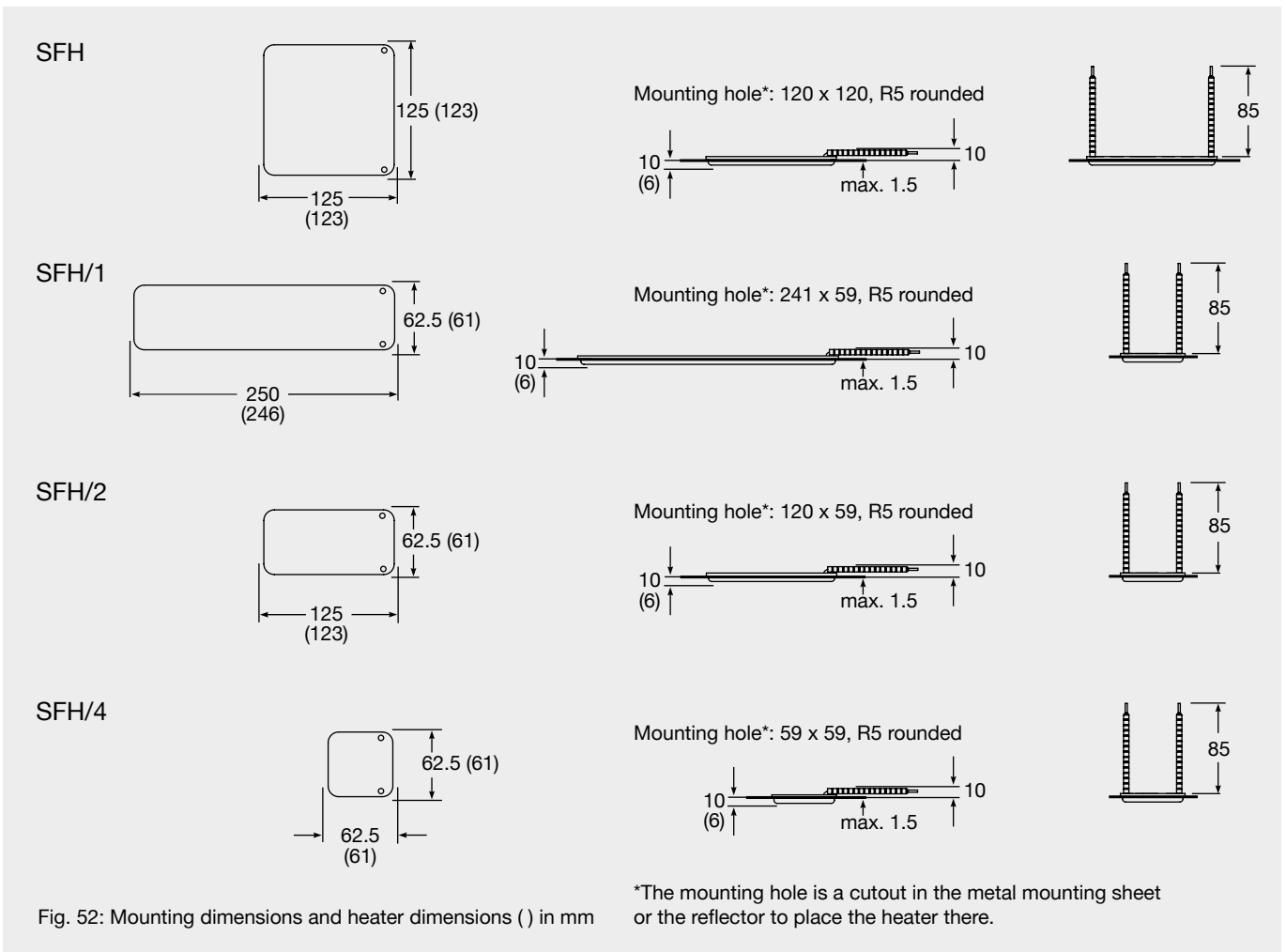
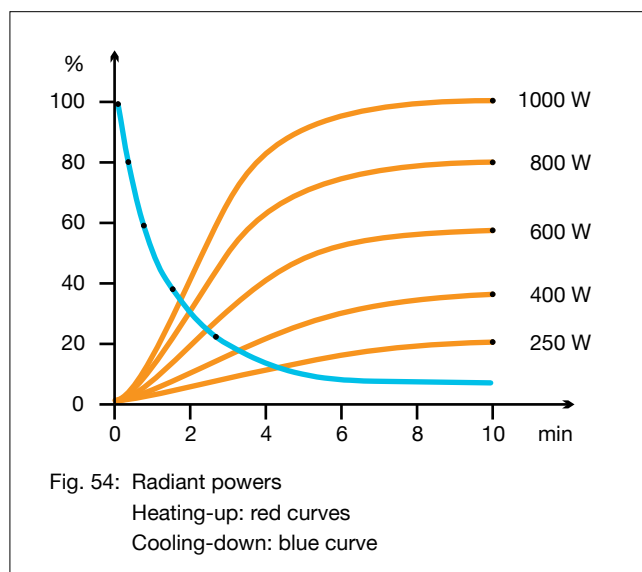
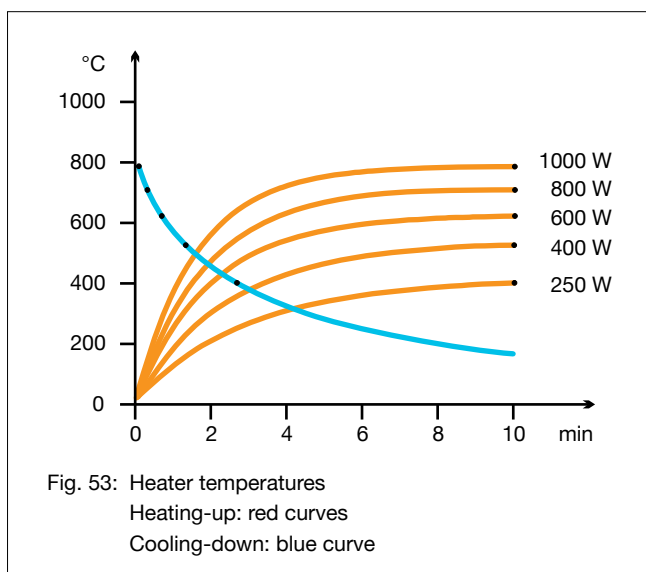



Fig. 52: Mounting dimensions and heater dimensions () in mm



Type, weight, wattage	SFH/1, SFH	160 g	250	400	600	800	1000	W
	SFH/2	85 g	125	200	300	400	500	W
	SFH/4	45 g	60	100	150	200	250	W
Installable surface rating			16.0	25.6	38.4	51.2	64.0	kW/m ²
Typical operating temperature			to 440	to 540	to 630	to 720	to 800	°C
Maximum permissible temperature			900	900	900	900	900	°C
Wavelength range			2 - 10					µm

Standard design	Thermocouple heaters	Variants
<p>Operating voltage 230 V Ceramic full-pour casting Black glaze Leads 85 mm</p> <p><u>Optional accessory</u> THI Thermal insulation sheet 1000 x 500 x 12 mm</p> 	<p>Designation T-SFH, T-SFH/1, T-SFH/2, T-SFH/4 Integrated thermocouple Type K (NiCr-Ni) TC leads 100 mm</p> 	<p>Special wattages Special voltages Extended leads Leads with ring terminals</p>

The power can be controlled using thermocouple heaters together with TRD 1 temperature controllers, TSE thyristor switching units and other accessories.

The national safety regulations must be complied with for the respective application, for example, the IEC or EN standard 60519-1, Safety in electrical heating installations.

Our instructions for mounting, operation and safety must be observed.



Bild 55: Elstein MSH/20 micro system heater

Elstein MSH micro system heaters are ceramic infrared heaters in small design. They reach operating temperatures up to 860 °C and surface ratings up to 100 kW/m².

MSH micro system heaters are used in applications, which require partial heating or drying of small goods and areas. This occurs for example at heating of printed circuit boards.

MSH heaters are suitable both for individual operation and for configuring groups of heaters to an infrared heating panel.

In this way small heating panels can be built, which can be adapted to the requirements of the heating task or the size as well as contours of the material to be heated regarding heated area, dimensions and the acuteness or the heating zones.

Elstein MSH micro system heaters are available with a power of 55 W 12 V.

MSH/20

Mounting hole: 9 x 21

The mounting hole is a cutout in the metal mounting sheet or the reflector to place the heater there.

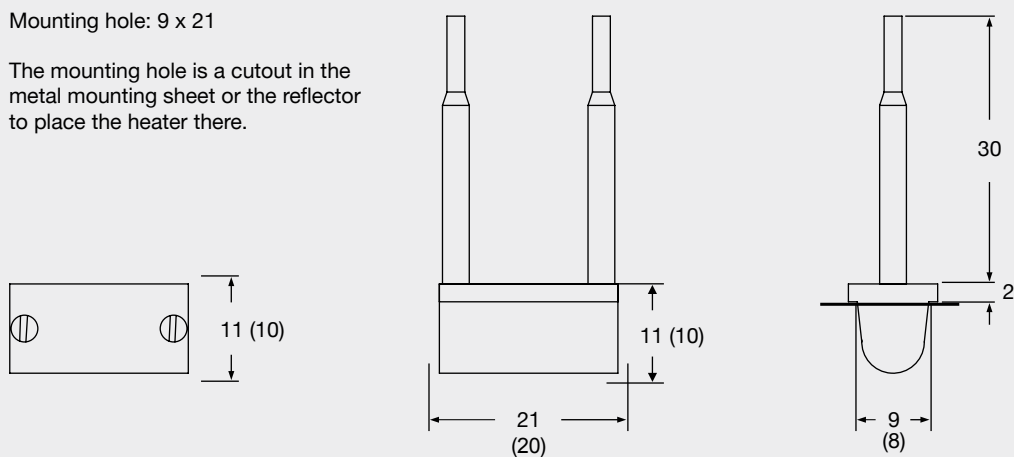
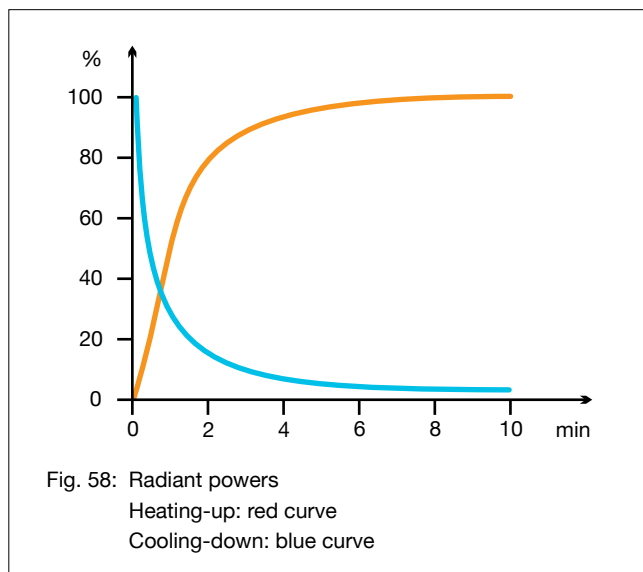
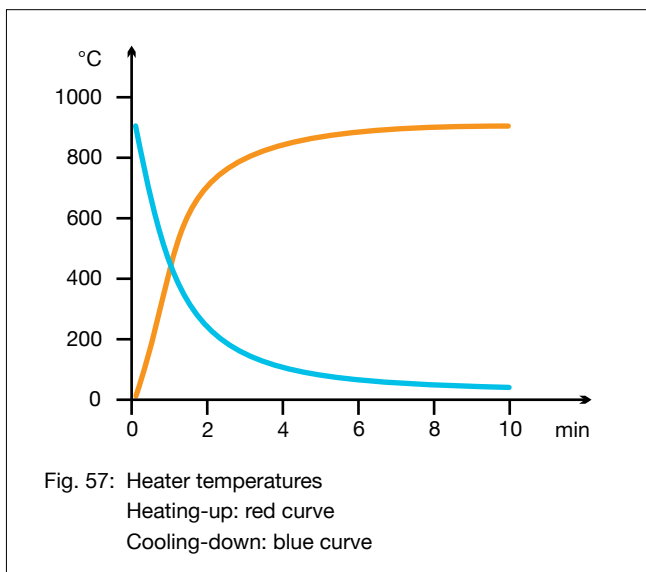



Figure 56: Mounting dimensions and heater dimensions () in mm



Type, weight, wattage	MSH/20	3 g	55	W
Installable surface rating			100	kW/m ²
Typical operating temperature			to 860	°C
Maximum permissible temperature			900	°C
Wavelength range			2 - 10	μm

<p>Standard design</p> <p>Operating voltage 12 V Ceramic full-pour casting Black glaze Leads 30 mm</p> <p><u>Optional accessory</u> THI Thermal insulation sheet 50 x 50 x 12 mm</p> 	<p>Thermocouple heaters</p> <p>Designation T-MSH/20 Integrated thermocouple Type K (NiCr-Ni) TC leads 53 mm</p> 	<p>Variants</p> <p>Special wattages Special voltages Extended leads Leads with ring terminals</p>
----------------------------------------------------------------------------------------------------------------------------------------------------------------------------------------------------------------------------------------------------------------------------------------------------------------------------------------------------------------------	---------------------------------------------------------------------------------------------------------------------------------------------------------------------------------------------------------------------------------------------------------------	-------------------------------------------------------------------------------------------------------------------------------------------------------------

The power can be controlled using thermocouple heaters together with TRD 1 temperature controllers, TSE thyristor switching units and other accessories.

The national safety regulations must be complied with for the respective application, for example, the IEC or EN standard 60519-1, Safety in electrical heating installations.

Our instructions for mounting, operation and safety must be observed.

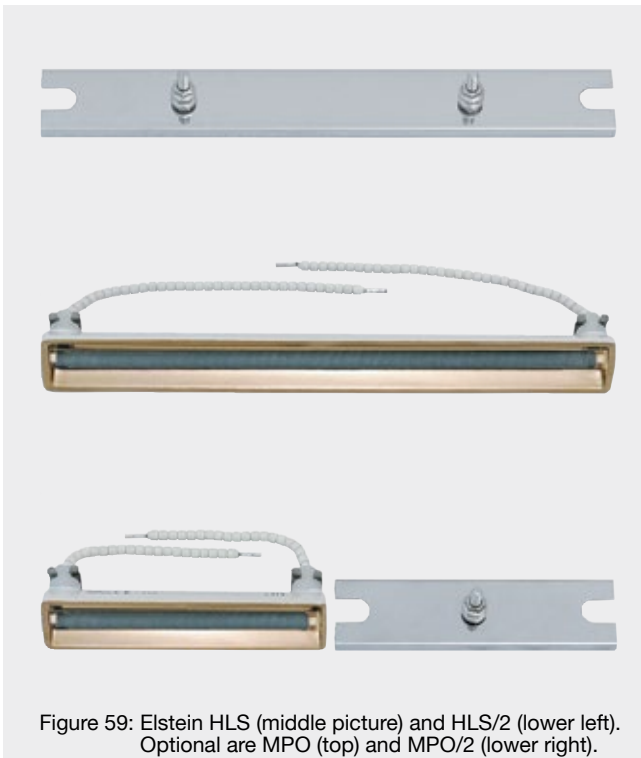

Figure 59: Elstein HLS (middle picture) and HLS/2 (lower left). Optional are MPO (top) and MPO/2 (lower right).

Elstein HLS high performance heaters are ceramic infrared rod heaters, which can be used for operating temperatures up to 1000 °C and surface ratings up to 87 kW/m².

HLS series heaters have a gold-plated ceramic parabolic reflector and transfer up to 80% of the energy supplied as infrared radiation to the material to be heated.

In this way, HLS heaters allow material temperatures of up to 700 °C or high throughput speeds. The typical operating temperature of 1000 °C is reached in less than one minute.

HLS series heaters are therefore particularly suitable for use in plant construction, in which special solutions have to be drawn up for the customer's specific needs and for applications requiring high outputs.

Elstein HLS high performance heaters are available in two designs with 750 W / 230 V and for pairwise serial connection with 375 W / 115 V.

HLS

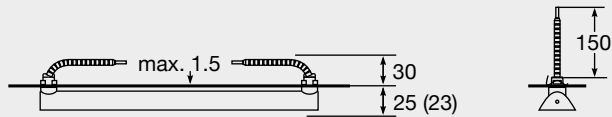
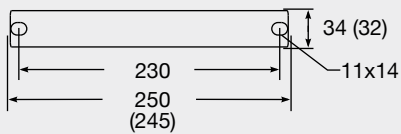

T-HLS: The length 250 (245) extends due to the thermocouple clamp by 6 mm

HLS/2

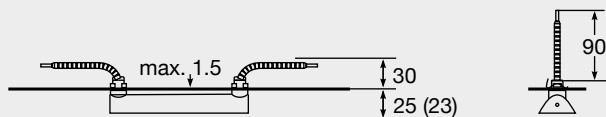
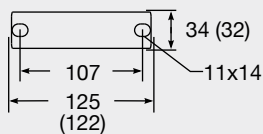

T-HLS/2: The length 125 (122) extends due to the thermocouple clamp by 6 mm

T-HLS and T-HLS/2

HLS series with platinum thermocouple type S (blue printed), assembled

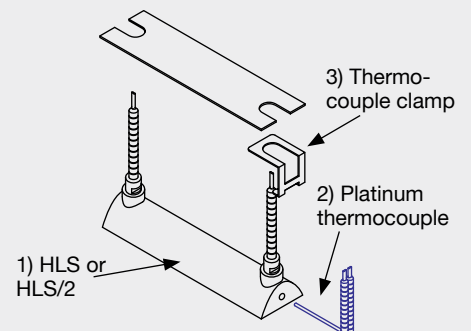
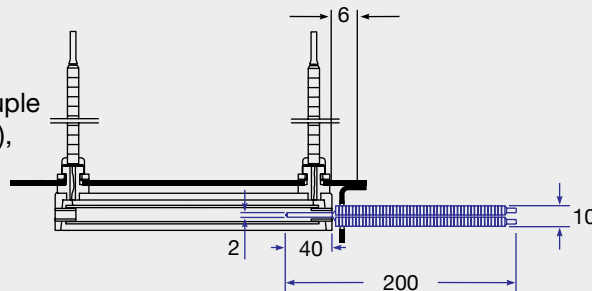
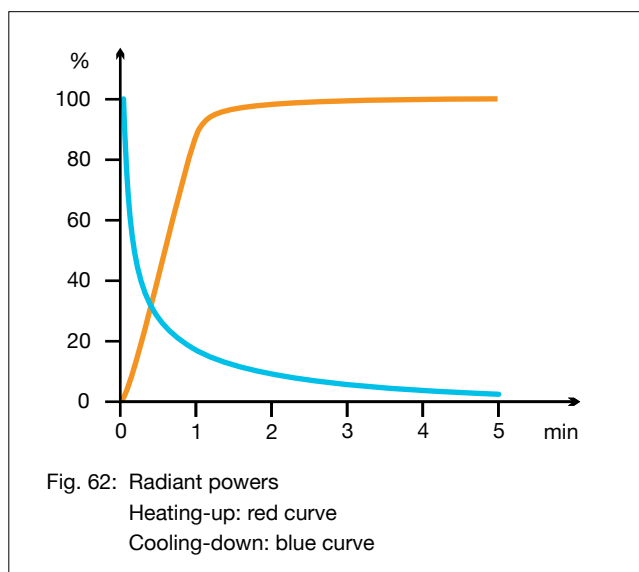
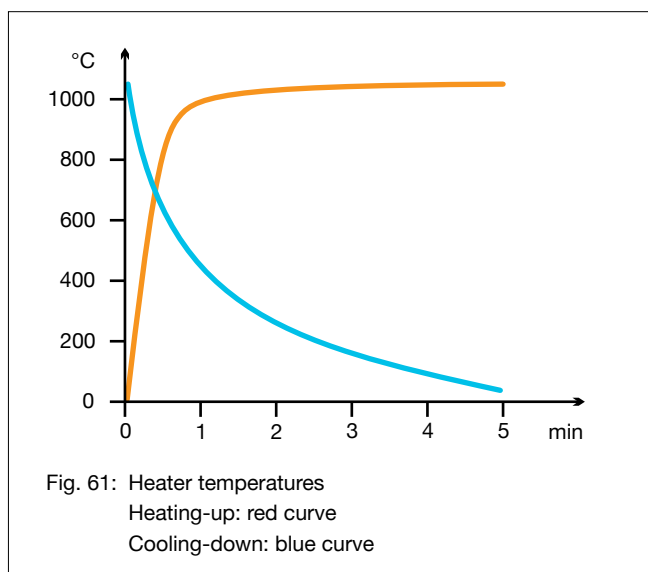

Figure 60: Mounting dimensions and heater dimensions () in mm



Type, weight, wattage	HLS	120 g	750	W
	HLS/2	60 g	375	W
Installable surface rating			87.0	kW/m ²
Typical operating temperature			to 1000	°C
Maximum permissible temperature			1100	°C
Wavelength range			2 - 10	μm

<p>Standard design</p> <p>HLS operating voltage 230 V HLS/2 operating voltage 115 V HLS leads 150 mm HLS/2 leads 90 mm Parabolic reflector gold-plated on the inside</p>	<p>Thermocouple heaters</p> <p>Kit T-HLS and T-HLS/2 for self-assembly, consisting of</p> <ol style="list-style-type: none"> 1) HLS or HLS/2 2) Platinum-thermocouple type S 3) Thermocouple clamp <p>Figure: Assembly example of T-HLS/2 with mounting profile MPO/2</p>	<p>Variants</p> <p>Special wattages Special voltages Extended leads Leads with ring terminals</p>
-----------------------------------------------------------------------------------------------------------------------------------------------------------------------------------------------------------------------------------------------------	-------------------------------------------------------------------------------------------------------------------------------------------------------------------------------------------------------------------------------------------------------------------------------------------------------------------	-------------------------------------------------------------------------------------------------------------------------------------------------------------

Elstein HLS heaters must be operated with temperature control to avoid damage due to overheating. The power can be controlled using proprietary sheathed thermocouples as well as Elstein platinum-thermocouples (both type S, Pt-PtRh) in conjunction with TRD 1 temperature controllers, TSE thyristor switching units and further accessories.

IR radiation areas can be assembled using MPO mounting profiles.

The national safety regulations must be complied with for the respective application, for example, the IEC or EN standard 60519-1, Safety in electrical heating installations.

Our instructions for mounting, operation and safety must be observed.

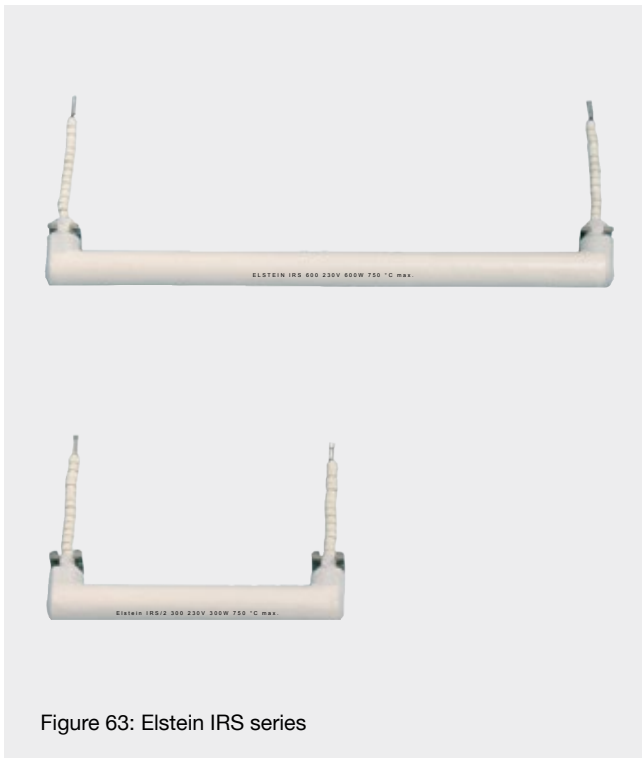

Figure 63: Elstein IRS series

Elstein IRS rod heaters are ceramic infrared heaters, designed for operating temperatures of up to 650 °C. With the help of MPO and MPO/2 mounting profiles, surface ratings of up to 72.0 kW/m² can be realised.

IRS series heaters have one mounting socket on each side, with which they can be fixed to a mounting profile with fixing springs.

The rod shaped design makes IRS heaters preferably suitable for linear heating tasks.

An example for linear heating tasks can be found in the timber industry, where IRS rod heaters are used to pre-heat edge strips.

Elstein IRS rod heaters are available in two designs and wattages of 400 and 600 W.

IRS

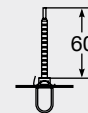
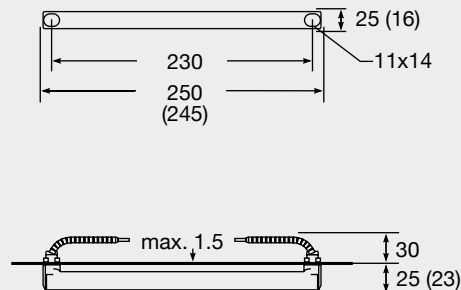

IRS/2

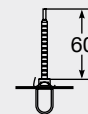
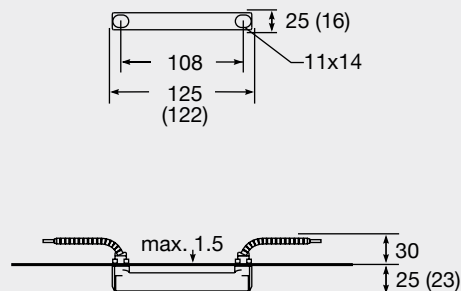
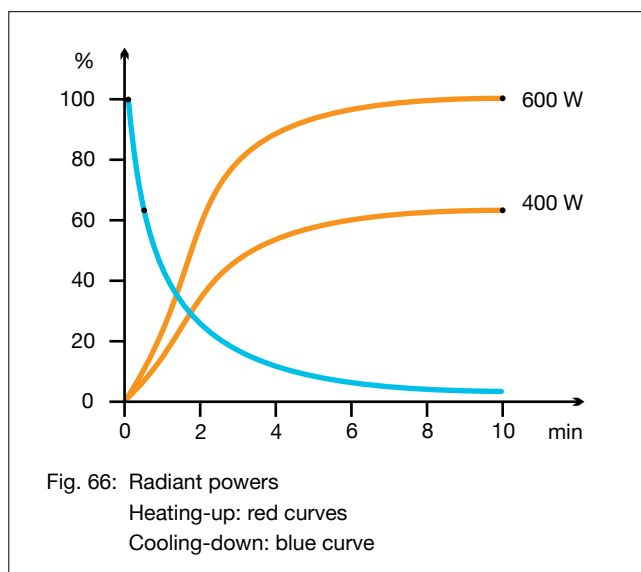
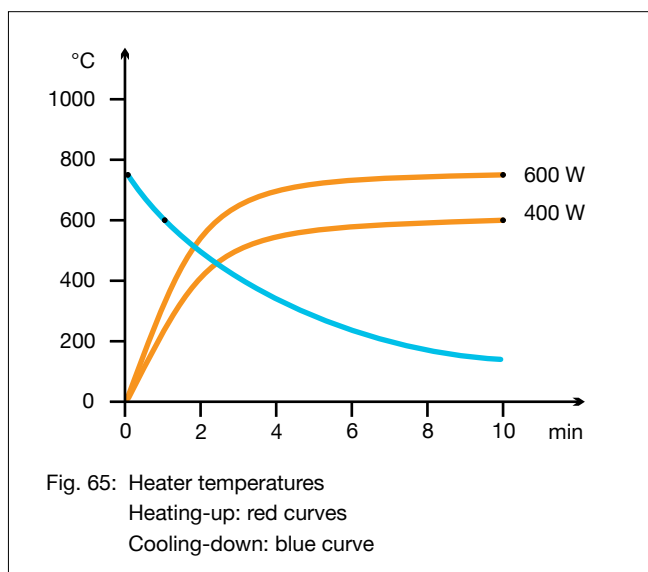



Figure 64: Mounting dimensions and heater dimensions () in mm



Type, weight, wattage	IRS	95 g	400	600	W
	IRS/2	50 g	200	300	W
Installable surface rating			48.0	72.0	kW/m ²
Typical operating temperature			to 550	to 650	°C
Maximum permissible temperature			750	750	°C
Wavelength range			2 - 10		µm

<p>Standard design</p> <p>Operating voltage 230 V Leads 60 mm Two mounting sockets Two fixing springs</p>	<p>Thermocouple heaters</p> <p>Designation T-IRS, T-IRS/2 Integrated thermocouple Type K (NiCr-Ni) TC leads 100 mm</p> 	<p>Variants</p> <p>Special wattages Special voltages Extended leads Leads with ring terminals</p>
---------------------------------------------------------------------------------------------------------------------------------------------------------------------	----------------------------------------------------------------------------------------------------------------------------------------------------------------------------------------------------------------------------------------------------------------------	-------------------------------------------------------------------------------------------------------------------------------------------------------------

The power can be controlled using thermocouple heaters together with TRD 1 temperature controllers, TSE thyristor switching units and other accessories.

IR radiation areas can be assembled using MPO mounting profiles.

The national safety regulations must be complied with for the respective application, for example, the IEC or EN standard 60519-1, Safety in electrical heating installations.

Our instructions for mounting, operation and safety must be observed.

Ceramic Infrared Screw Heaters



Figure 67: Elstein IOT/75 and IOT/90

Elstein IOT/75 and IOT/90 heaters are ceramic infrared heaters with E27 screw caps.

The standardised E27 thread allows easy and safe installation, as the heaters can be screwed in like bulbs into porcelain sockets or metal sockets with porcelain insert.

Due to their simple connection, IOT/75 and IOT/90 infrared heaters are suitable both for individual operation and for configuring groups of heaters. They have diverse applications, in particular they range over terrariums/pets and livestock, breeding, medical and catering technology.

The power can be adjusted by using a proprietary dimmer.

Elstein IOT/75 and IOT/90 heaters are available in two power levels of 60 W and 100 W or rather 150 W and 250 W.

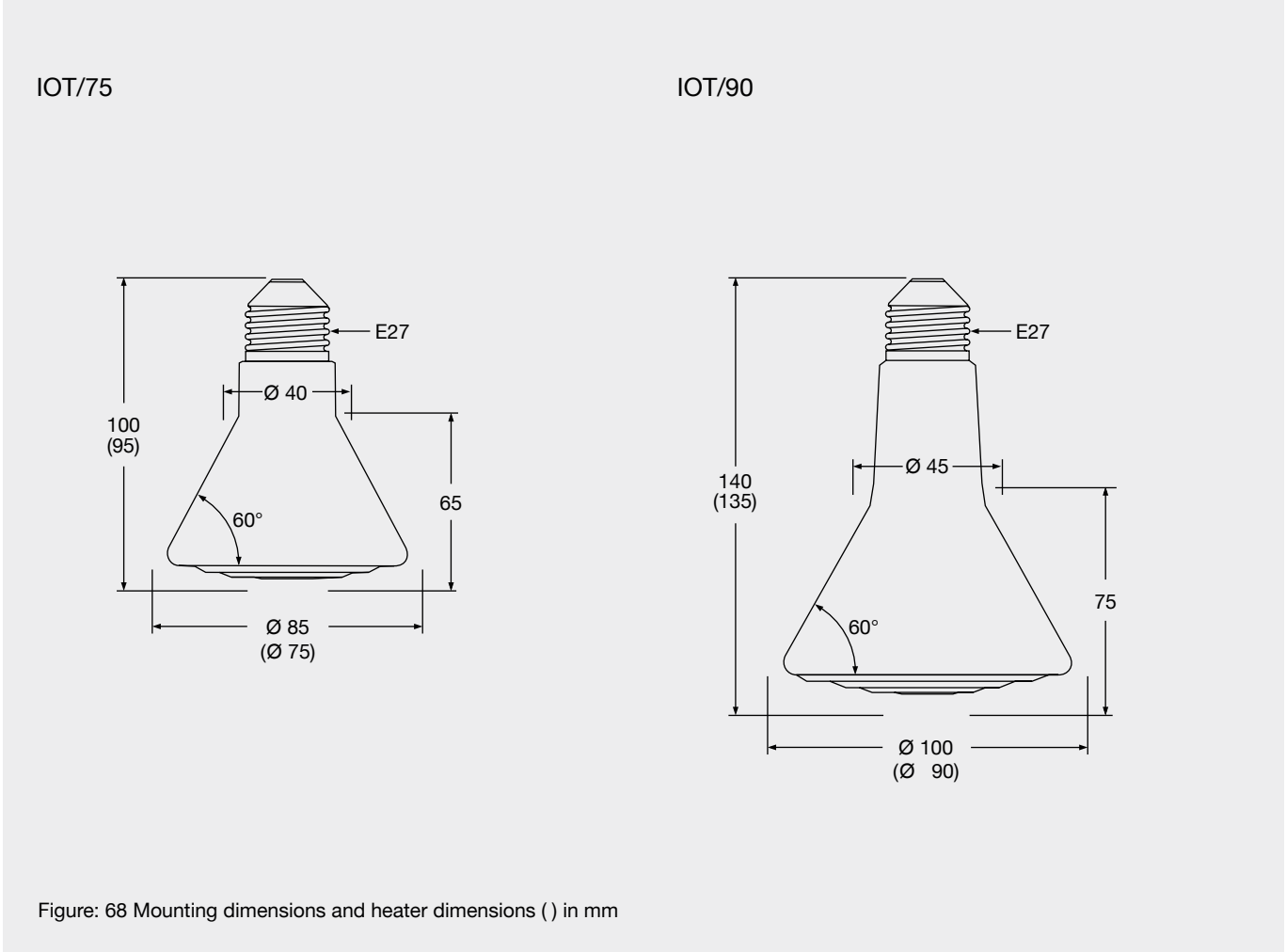
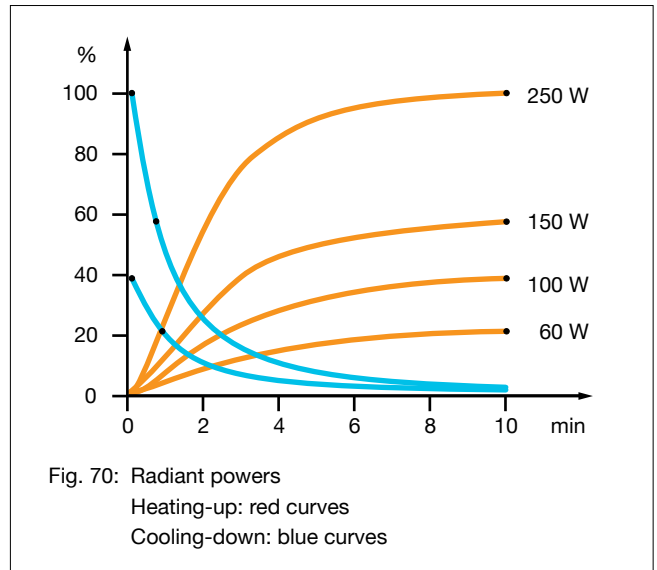
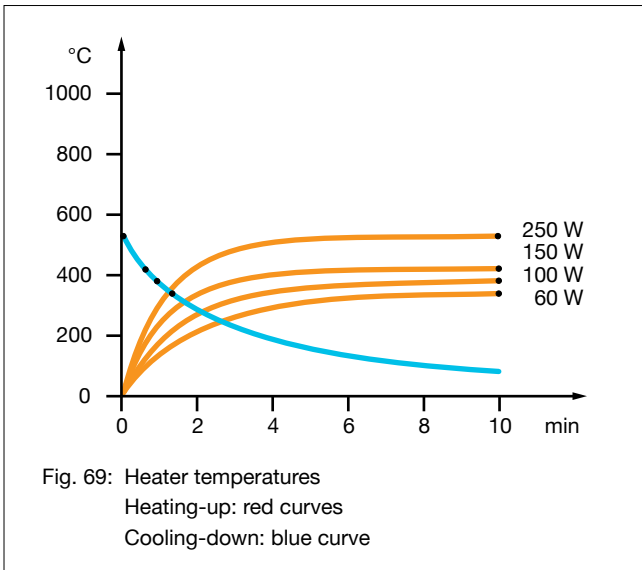

Figure: 68 Mounting dimensions and heater dimensions () in mm



Type, weight, wattage	IOT/75	85 g	60	100	-	-	W
	IOT/90	140 g	-	-	150	250	W
Installable surface rating			8.6	14.4	15.0	25.0	kW/m ²
Typical operating temperature			to 290	to 380	to 420	to 490	°C
Maximum permissible temperature			530	530	530	530	°C
Wavelength range			3 - 10				µm

Standard design Operating voltage 230 V Ceramic hollow casting E27 Edison screw cap	Thermocouple heaters Not available. For means of controlling output see below.	Variants Special wattages Special voltages Coloured glazes
-----------------------------------------------------------------------------------------------------	-------------------------------------------------------------------------------------------------	----------------------------------------------------------------------------

The power can be adjusted using proprietary power controllers or dimmers.

Porcelain sockets or metal sockets with porcelain inserts are to be used both for electrical and mechanical connection of Elstein IOT/75 and IOT/90 heaters. The sockets must not contain any plastic components.

The national safety regulations must be complied with for the respective application, for example, the IEC or EN standard 60519-1, Safety in electrical heating installations and VDE 0700 Part 71 or EN 60335-2-71, Regulations for Electrical heaters in animal breeding and keeping of livestock.

Our instructions for mounting, operation and safety must be observed.



Fig. 71: Elstein construction set REF/250 with SHTS/1 (Top)
Elstein construction set REF/125 with SHTS/2 (Down)

By quoting the REF/250 or REF/125 construction set designations and the heater type required, the REO/250 and REO/125 reflectors are available fitted with the FSR, FSM, HFS, HSR, HTS and SHTS series ceramic infrared panel heaters.

The REO reflectors are made from polished stainless steel. They are used to hold and fix panel heaters with the dimensions 245 mm x 60 mm (Figure 73) and 122 mm x 60 mm (Figure 74) as well as for reflecting the IR radiation in the direction of the material to be heated.

The REF system can be used to assemble IR radiation areas with any geometry. When building heating areas or plants a closed wiring space has to be considered for the electrical connections of the REF system.

The Elstein range of products includes the EBF construction elements and the BSI construction panels as fitted heating area solution, in which the electrical connections are situated in a housing.

REF/250

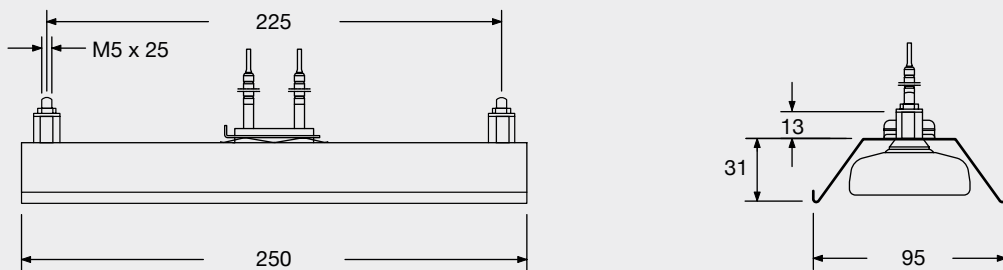

REF/125

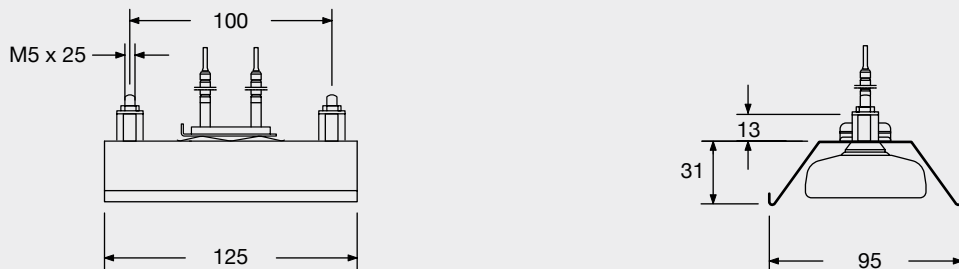

Figure 72: Mounting dimensions and REF dimensions () in mm

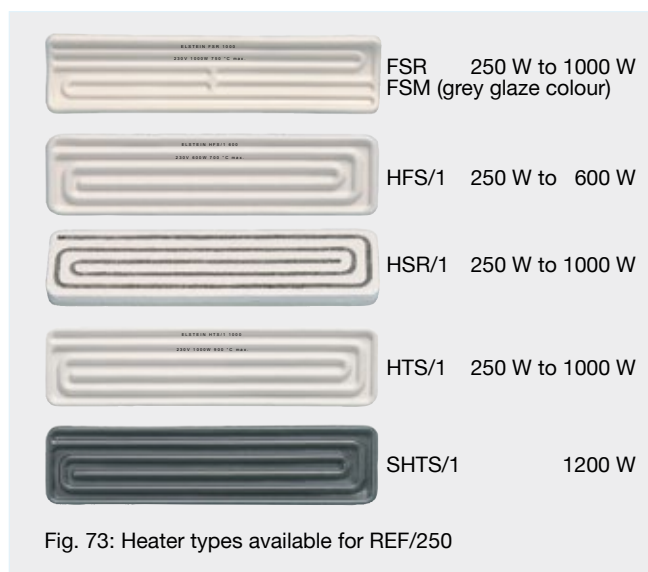

Fig. 73: Heater types available for REF/250



Fig. 74: Heater types available for REF/125

Reflector and heater type	REF/250, equipped with...						
	FSM	FSR	HFS/1	HSR/1	HTS/1	SHTS/1	
	REF/125, equipped with...						
	FSM/2	FSR/2	HFS/2	HSR/2	HTS/2	SHTS/2	
Maximum possible surface rating	40.0	40.0	24.0	40.0	40.0	48.0	kW/m ²
Maximum possible typical operating temperature	to 720	to 720	to 630	to 860	to 860	to 860	°C
Maximum permissible temperature	750	750	700	900	900	900	°C
Wavelength range	2 - 10						µm

Standard design	Thermocouple heaters	Variants
<p>Reflector made from polished stainless steel with two M5 x 25 fixing screws, spacer bolts and M5 nuts (fitted)</p> <p>Ceramic infrared heater, fixed to the reflector</p>	<p>Available for all above-mentioned heater types.</p> <p>Designation REF/... with T-...</p> <p>For example: REF/250 with T-HTS/1 250 W 230 V</p>	<p>Special wattages</p> <p>Special voltages</p> <p>Extended leads</p> <p>Leads with ring terminals</p> <p>REO/250S and REO/125S Width 62,5 mm instead of 95 mm For compact heater mounting</p>

The power can be controlled using thermocouple heaters together with TRD 1 temperature controllers, TSE thyristor switching units and other accessories.

The national safety regulations must be complied with for the respective application, for example, the IEC or EN standard 60519-1, Safety in electrical heating installations.

Our instructions for mounting, operation and safety must be observed.



Figure 75: Elstein Construction Elements EBF

Elstein EBF construction elements are linear heating panels being assembled in our factory.

They can be equipped with Elstein ceramic panel heaters of the width 60 mm. A combination of different sizes and wattages within the same heater type is possible.

The user does the wiring and the connection with the electricity mains.

Optionally EBF is available with silicone coated cables.

Heating panels can be realised in any sizes, geometries and positions with Elstein Construction Elements EBF.

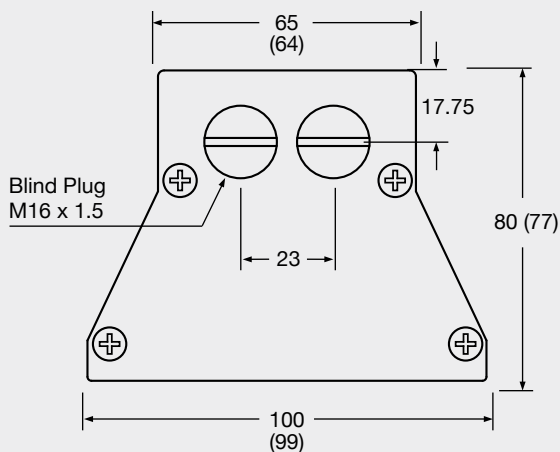
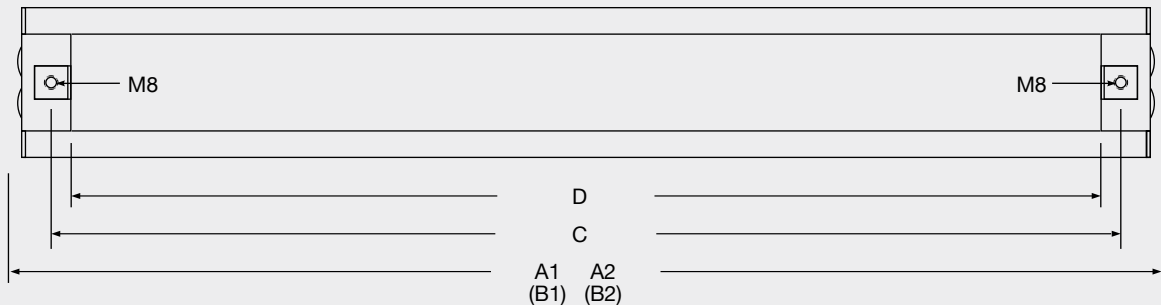
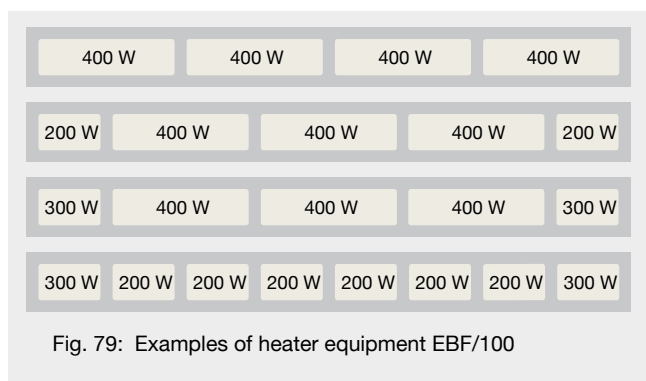
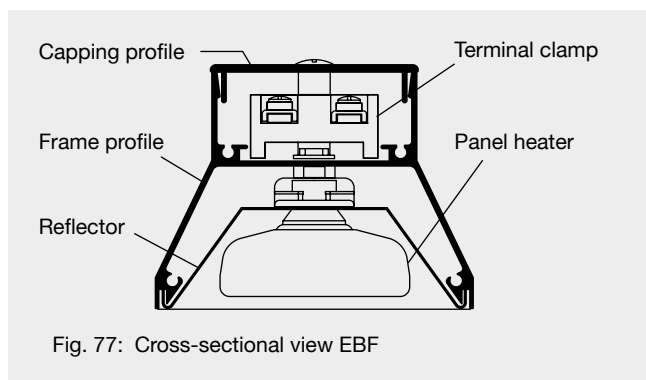

Figure 76: Mounting dimensions and EBF dimensions () in mm

	A1	B1	A2	B2	C	D
	With M16 x 1.5 Blind Plug		No M16 x 1.5 Blind Plug			
EBF/25	270	262	260	255	217	190
EBF/50	520	512	510	505	467	440
EBF/75	770	762	760	755	717	690
EBF/100	1020	1012	1010	1005	967	940
EBF/125	1270	1262	1260	1255	1217	1190
Other lengths on request						



Construction Elements EBF are equipped with the following single components:

Ceramic Infrared Heaters

Equipment with panel heaters of the Elstein standard series.

Depending on the selection of heater types and designs, the maximum heaters' surface rating can be up to 76.8 kW/m² for housing lengths up to 500 mm and from 750 mm up to 38.4 kW/m². Heaters with integrated thermocouple can be selected for temperature control purposes.

Reflectors

The reflectors are made from polished stainless steel. They are used for focussing the radiation energy in the direction of the material to be heated. Optionally the reflectors are available separately, too.

Frame and Capping Profile

The frame and capping profile is made from aluminium. The end pieces on the front sides of the frame profile have one thread M8 each for screwing the EBF construction elements on a holder being manufactured by the user. The end pieces also include a labelled safety earth terminal and two drillings with thread M16 for feeding through the cables. The drillings are closed by removable blind plugs. Optionally there are cable glands M16 with strain relief available from our assortment.

Bipolar Terminal Clamps AK

For wiring the ceramic infrared heaters.

Accessories

Temperature controller, thyristor switching units, reflectors, cable glands with strain relief, and wiring material is available in our standard assortment.

Please observe our instructions for mounting, operation and safety.



Figure 81: Elstein EBI construction element made from stainless steel, equipped with HTS/1

Elstein EBI construction elements are infrared radiation systems, whose housing parts are made from stainless steel. EBI systems are corrosion resistant and mechanically as well as thermally very stable. Therefore they are very suited for applications, where such requirements have to be fulfilled; for example in the food industry.

Elstein EBI construction elements are assembled in our factory. They can be equipped with Elstein ceramic panel heaters FSM, FSR, HTS/1, SHTS/1, HSR/1 and FSM/2, FSR/2, HTS/2, SHTS/2, HSR/2, whereby it is also possible to combine different heater designs and wattages of the same types of heaters.

The user only has to do the wiring, fix the EBI elements in a steel section frame to be made on site and connect up with the electricity mains.

Elstein EBI construction elements are available in many lengths and can be fitted together to form radiation panels in any installed position as well as geometry.

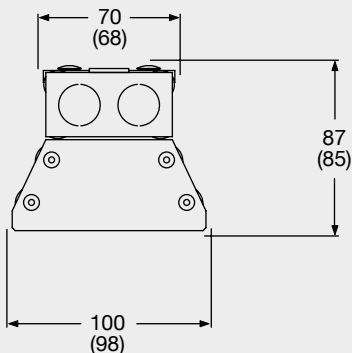
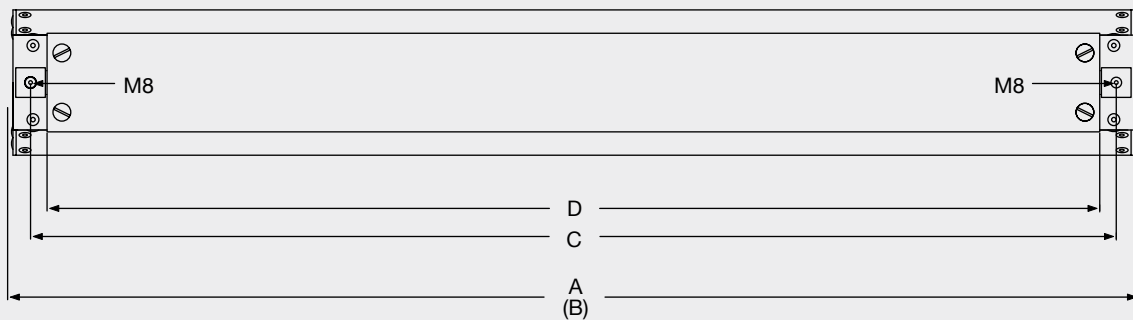

	A	B	C	D		A	B	C	D
EBI/25	260	257	233	210	EBI/87,5	894	885	861	838
EBI/37,5	386	383	359	336	EBI/100	1020	1010	986	963
EBI/50	513	508	484	461	EBI/112,5	1148	1136	1112	1089
EBI/62,5	641	634	610	587	EBI/125	1275	1261	1237	1214
EBI/75	767	759	735	712	Other lengths available on request (from 125 mm to 2500 mm and longer)				

When exchanging EBF against EBI varying dimensions of housing and installation must be considered.

Figure 82: Mounting dimensions and EBI dimensions () in mm

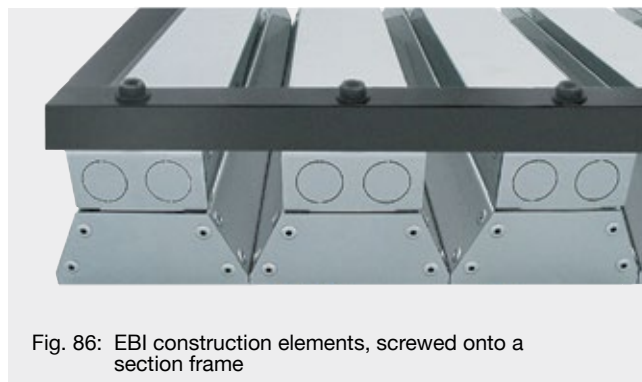
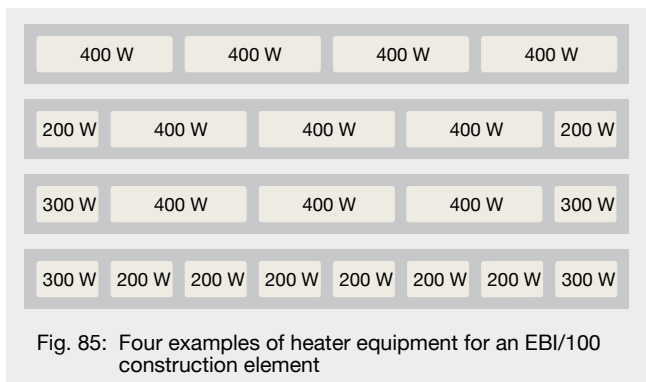
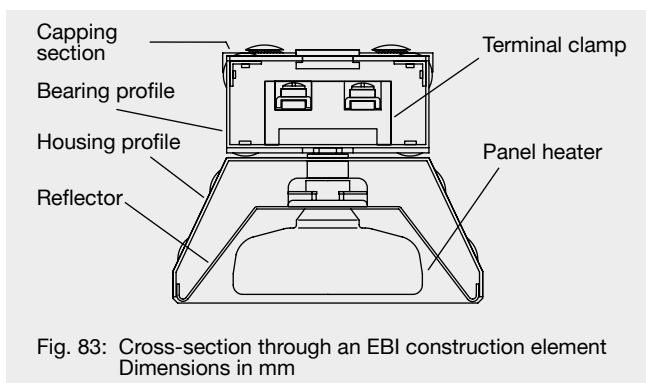

Standard scope of delivery (variants and other lengths are available on request)

Ceramic infrared heaters, fitted, selectable heater types:

FSM, FSR, HSR/1, HTS/1, SHTS/1, FSM/2, FSR/2, HSR/2, HTS/2, SHTS/2

The maximum heater power level available is 1200 W. Mixed heater wattages and dimensions can be fitted.

Thermocouple heaters for temperature control are installed in the EBI construction element at the request of the customer. Accessories for controlling the temperature, such as the TRD 1 temperature controller and TSE thyristor switching units are included in the Elstein range of products.

REO reflectors for the heater dimensions 245 mm x 60 mm and 122 mm x 60 mm, fitted

The REO reflectors are made from polished stainless steel. They are used for holding and fixing the heaters as well as reflecting the IR radiation in the direction of the material to be heated. On request, the reflectors fitted with ceramic infrared heaters are also available separately under the type designations REF/250 and REF/125.

Housing and bearing profiles, capping sections, appropriate end pieces, all made from stainless steel, fitted

For mounting the ceramic infrared heaters fixed to the REO reflectors. Each EBI consists of a housing profile with 2 end pieces, 1 bearing profile with 2 appropriate end pieces and a capping section. The end pieces of the bearing profile have 2 ring slits each. Cutting the land at the ring slit releases holes to insert M20 threaded joints for the electric power supply.

AK bipolar terminal clamps, fitted and connected with heater power leads

For wiring the ceramic infrared heaters. The Elstein range of products includes accessories for the wiring, heat resistant flexible metal hoses and screw fitting accessories. The hoses are used to hold the nickel wire and thermo line and to protect them from mechanical stress.

Our instructions for mounting, operation and safety must be observed.



Figure 87: Elstein BSI construction panel 1250 x 1875 mm equipped with HTS

Elstein BSI construction panels are infrared radiation areas, which can be equipped with the ceramic IR panel heaters HTS or HSR.

The ceramic infrared panel heaters are fixed to the MBO mounting sheets and surrounded with a housing of frame and capping sections.

All housing parts consist of stainless steel so that heaters with high power can be used, too.

The BSI construction panels are factory assembled so that the user only has to do the wiring, insert the BSI panel in a steel section frame to be made on site and connect the panel with the electricity mains.

Elstein BSI construction panels can be fitted with HTS heaters up to 800 W or rather with HSR heaters up to 1000 W and are suited for building infrared heating areas in any dimensions.

Length in mm

Inner dim. (Outer dim.) [No. of rad.]	250 (261) [2]	375 (386) [3]	500 (511) [4]	625 (636) [5]	750 (761) [6]	875 (886) [7]	1000 (1011) [8]	1125 (1136) [9]	1250 (1261) [10]	1375 (1386) [11]	1500 (1511) [12]		Heater wattage
125 (136) [1]	0.50 to 2.00	0.75 to 3.00	1.00 to 4.00	1.25 to 5.00	1.50 to 6.00	1.75 to 7.00	2.00 to 8.00	2.25 to 9.00	2.5 to 10.00	2.75 to 11.00	3.00 to 12.00	kW	250 W to 1000 W
250 (261) [2]	1.00 to 4.00	1.50 to 6.00	2.00 to 8.00	2.50 to 10.00	3.00 to 12.00	3.50 to 14.00	4.00 to 16.00	4.50 to 18.00	5.00 to 20.00	5.50 to 22.00	6.00 to 24.00	kW	250 W to 1000 W
375 (386) [3]	1.50 to 6.00	2.25 to 9.00	3.00 to 12.00	3.75 to 15.00	4.50 to 18.00	5.25 to 21.00	6.00 to 24.00	6.75 to 27.00	7.50 to 30.00	8.25 to 33.00	9.00 to 36.00	kW	250 W to 1000 W
500 (511) [4]	2.00 to 8.00	3.00 to 12.00	4.00 to 16.00	5.00 to 20.00	6.00 to 24.00	7.00 to 28.00	8.00 to 32.00	9.00 to 36.00	10.00 to 40.00	11.00 to 44.00	12.00 to 48.00	kW	250 W to 1000 W
625 (636) [5]	2.50 to 10.00	3.75 to 15.00	5.00 to 20.00	6.25 to 25.00	7.50 to 30.00	8.75 to 35.00	10.00 to 40.00	11.25 to 45.00	12.50 to 50.00	13.75 to 55.00	15.00 to 60.00	kW	250 W to 1000 W
750 (761) [6]	3.00 to 12.00	4.50 to 18.00	6.00 to 24.00	7.50 to 30.00	9.00 to 36.00	10.50 to 42.00	12.00 to 48.00	13.50 to 54.00	15.00 to 60.00	16.50 to 66.00	18.00 to 72.00	kW	250 W to 1000 W
875 (886) [7]	3.50 to 14.00	5.25 to 21.00	7.00 to 28.00	8.75 to 35.00	10.50 to 42.00	12.25 to 49.00	14.00 to 56.00	15.75 to 63.00	17.50 to 70.00	19.25 to 77.00	21.00 to 84.00	kW	250 W to 1000 W
1000 (1011) [8]	4.00 to 16.00	6.00 to 24.00	8.00 to 32.00	10.00 to 40.00	12.00 to 48.00	14.00 to 56.00	16.00 to 64.00	18.00 to 72.00	20.00 to 80.00	22.00 to 88.00	24.00 to 96.00	kW	250 W to 1000 W

Maximum surface rating 64.0 kW/m² Weight approx. 50 kgs/m² Other dimensions and surface ratings available on request
The outer dimensions indicated in the table do not include the mounting fishplates.

Figure 88: Overview of the standard dimensions, outer dimensions (), number of heaters [] and the connected loads in kW

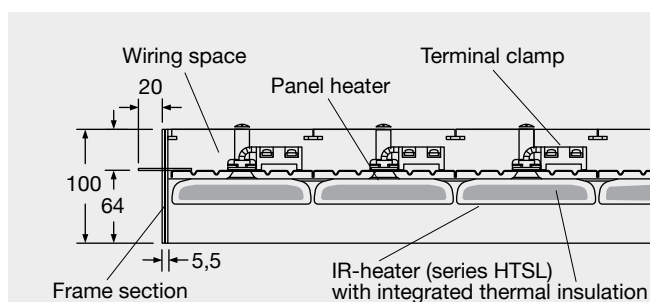

Fig. 89: Structural design of the BSI construction panel
Dimensions in mm

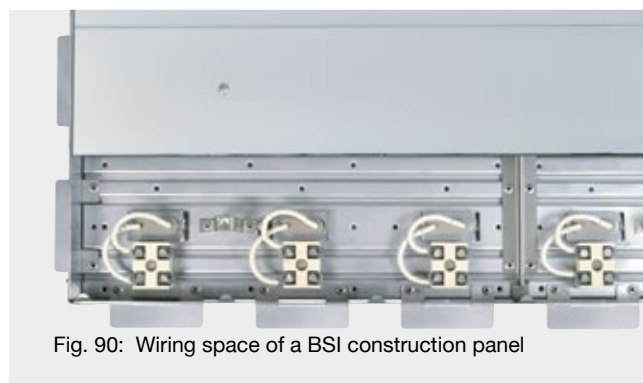

Fig. 90: Wiring space of a BSI construction panel

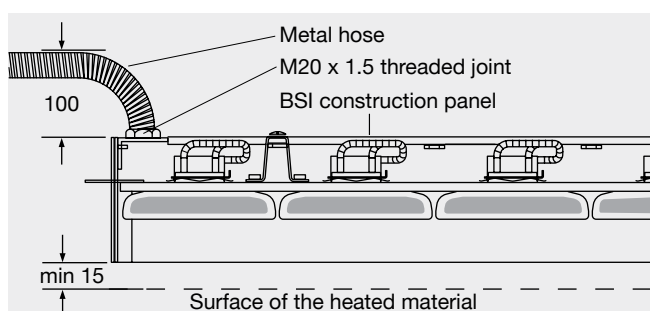

Fig. 91: Arrangement of the connection unit for establishing the mains connection. Dimensions in mm



Fig. 92: BSI construction panel, inserted in a steel section frame

Standard scope of delivery (variants available on request)

Ceramic infrared heaters HTS and T-HTS or HSR and T-HSR, fitted

Heaters can be chosen from the heater power ratings 250 W, 400 W, 600 W and 800 W. The HSR heaters can be fitted also up to 1000 W. Mixed heater wattages can also be fitted. One heater with integrated thermocouple (T-HTS or T-HSR respectively) is provided for each construction panel.

Frame sections with mounting fishplates and capping sections both made from stainless steel, fitted

These components are used to surround the ceramic infrared heaters fixed to the MBO mounting sheets and to hang the BSI construction panel into a steel section frame to be built on site.

AK bipolar terminal clamps, fitted and connected with heater power leads

For the electrical wiring of the individual heaters in conjunction with heat resistant insulated nickel wires and the connection of the thermocouple in conjunction with the heat resistant insulated thermo line.

Mounting units, enclosed, individual parts are not fitted

A mounting unit contains an angle section, up to 3 heat resistant flexible metal hoses with a length of 1m and screw fitting accessories. The hoses are used to hold the nickel wire and thermo line and to protect them from mechanical stress. The mounting units can be fixed to anywhere on the BSI frame section.

Wiring material (nickel wire, thermo line), enclosed

Nickel wire (2.5 mm², max. 500 °C, max. 11 A) is supplied for the electrical wiring of the ceramic infrared heaters. The thermo line (1 mm², max. 400 °C) is used to connect the thermocouple to the controller. The Elstein product range includes a compensating line (1.5 mm², max. 100 °C) for extending this connection outside the IR radiation area.

Our instructions for mounting, operation and safety must be observed.

Connection and Control Accessories

1) Elstein TRD 1 temperature controller

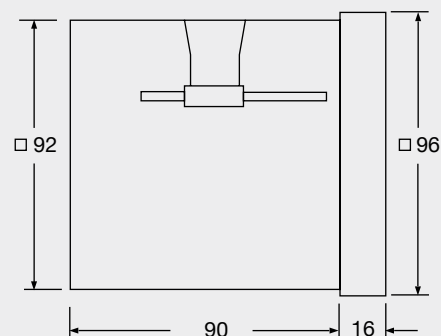

2) Elstein thyristor switching units



TSE 40 A



TSE 20 A

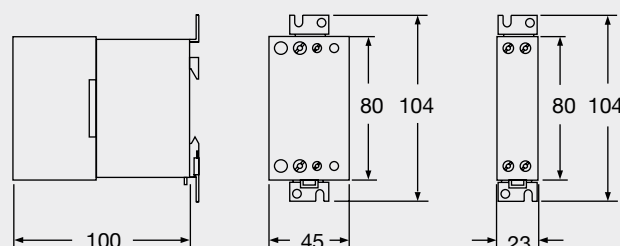

3) Elstein fuse holders



PST 14



PST 10

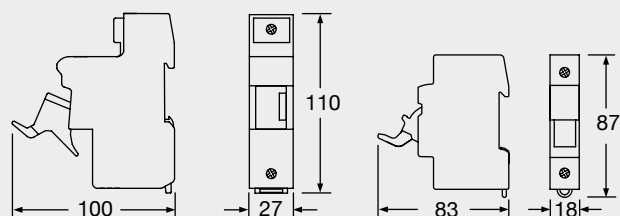

4) Elstein fuses



URG 50 A



URG 20 A

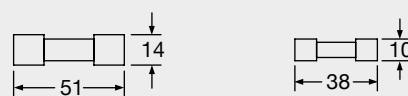

5) Elstein AK terminal clamp



6) Elstein nickel wire

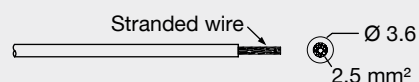
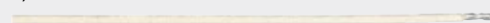

7) Elstein thermo line

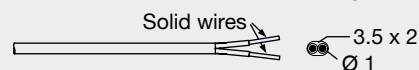

8) Elstein compensating line

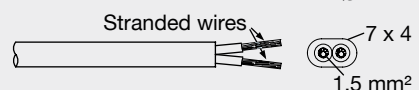

Figure 93: Electrical and temperature controlling accessories

Figure 94: Electrical and temperature controlling accessories
Dimensions in mm

Connection and Control Accessories

1) Elstein TRD 1 temperature controller

Type:	two point controller with PID performance
No. of switching units:	max. 6 TSE per controller
Temperature sensor:	NiCr-Ni + 16 further types
Control range:	up to 1100 °C
Setpoint setting:	in 1 °C steps, 4 setpoint values, distant access
Outputs:	2 x 0/12 V DC bi-stable load max. 30 mA and 2 relay outputs
Supply voltage:	95 V - 263 V, 48/63 Hz
Measuring circ. monit.:	outputs are switched off in case of break of sensor
Perm. ambient temp.:	0 - 55 °C
Perm. air humidity:	< 90%
Setpoint value display:	LCD 14.0 mm, green
Actual value display:	LCD 19.7 mm, red
Degree of protection:	front side IP 65 rear side IP 20
Connections:	screwed terminals
Installed position:	any
Dimensions:	DIN format 96 x 96 mm

The TRD 1 electronic temperature controllers analyse the signal of the thermocouple being integrated in each thermocouple heater. The TRD 1 temperature controllers operate as quasi-continuous controllers and their factory settings are specially matched to the controlled process performance of Elstein infrared systems, so that practically no temperature fluctuations occur.

The two 0/12V DC logical outputs control the TSE thyristor switching units. In addition, two programmable floating relay contacts are available, which can be used, for example, as alarm contacts in conjunction with the limit comparators.

Further information and safety information are given in the TRD 1 operating instruction.

2) Elstein TSE thyristor switching units

The TSE thyristor switching units are used to switch the load circuits (infrared heaters). They are available in two power stages:

TSE 40 A, max. 40 A = 9.2 kW at 230 V
TSE 20 A, max. 20 A = 4.6 kW at 230 V

TSE thyristor switching units are supplied complete with heat sink and mounting clips for 35-mm standard rails. They are not subjected to any contact wear and therefore do not cause any switching

noises. They are easy to install and their service life is virtually unlimited.

The loads are switched on at voltage zero and switched off at current zero. This means there is no system perturbation.

The load voltage is 24 - 265 V for TSE 20 A and 42 - 660 V for TSE 40 A. The control voltage is 4 - 32 V. A thyristor switching unit must be provided for each phase of a multi-phase connection to a 230/400 V alternating current mains.

The thyristor switching units must be protected against short circuits with super-agile fuses.

Transformers cannot be switched due to the Rush Effect.

Further information and safety information are given in the TSE operating instruction.

3) Elstein PST 14 fuse holder for URG 50 and PST 10 fuse holder for URG 20

The fuse holders can be clipped onto 35-mm standard rails and make a disconnection from the voltage possible according to the technical rules for safety. When changing the fuses, the front lever only has to be pressed down to expose the fuse shaft.

4) Elstein URG 50 A fuse for TSE 40 A and URG 20 A fuse for TSE 20 A

The super-agile fuses are used to protect the thyristor switching units against short circuits. Conventional fuses are unsuitable.

5) Elstein AK terminal clamp, bipolar, max. 480 V, max. 500 °C, consisting of steatite socket and stainless steel metal parts for cables with a maximum wire cross-section of 2.5 mm².

6) Elstein nickel wire, max. 500 °C, max. 11 A, stranded, single core, 2.5 mm² wire diameter, for the electrical connection of the ceramic infrared heaters.

7) Elstein thermo line, NiCr-Ni, max. 400 °C, for connecting the thermocouple integrated in the thermocouple heater with the temperature controller.

8) Elstein compensating line, stranded, NiCr-Ni, max. 100 °C, for extending the connection thermocouple-controller outside the IR radiation area.

Metal Parts

1) Elstein Housings



EBO/100



EBO/75



EBO/50



EBO/25

Further Elstein housings (without picture):

EBO/125

2) Elstein Reflectors



REO/250



REO/125

Further Elstein reflectors (without picture):

REO/250S and REO/125S for compact heater mounting (Width 62,5 instead of 95 mm)

3) Elstein Mounting profiles



MPO



MPO/2

4) Elstein Mounting sheets



MBO/500



MBO/375



MBO/250

5) Elstein mounting set



Slide (upper part)



Mounting spring (lower part)

6) Elstein fixing spring



Figure 95: Metal accessories

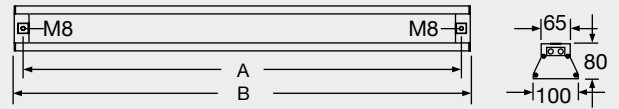

	A	B
EBO/125	1217	1260
EBO/100	967	1010
EBO/75	717	760
EBO/50	467	510
EBO/25	217	260

Other lengths available on request (from 125 mm to 2500 mm and longer)

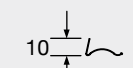
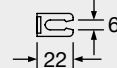
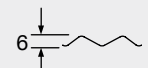
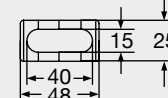
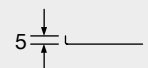
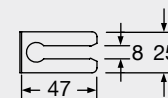
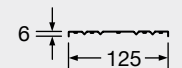
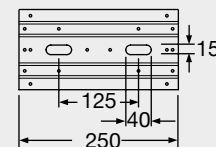
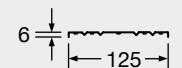
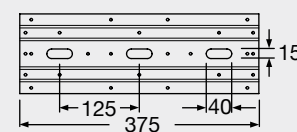
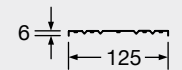
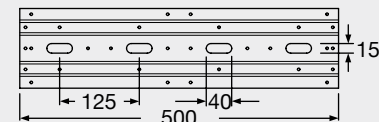
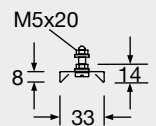
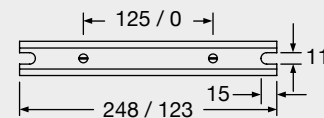
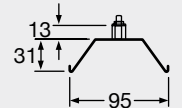
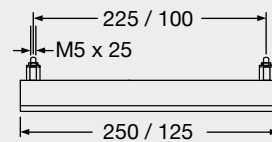

Figure 96: Metal accessories, Dimensions in mm

1) Elstein EBO housings

The EBO housings consist of an anodised, extruded aluminium section with an H-like cross-section, on which an aluminium capping section and two aluminium die cast end pieces are fitted.

Each die cast end piece contains a sliding nut with M8 thread for fixing the housings, for example on a steel section frame. They also contain a ceramic bushing for the electricity cables and a labelled safety earth terminal.

The EBO housings are available in the lengths 250 mm, 500 mm, 750 mm, 1000 mm and 1250 mm. Other sizes beginning from 125 mm length are also possible.

EBO housings being equipped with Elstein heaters are available as ready-for-assembly construction elements by using the designation EBF (see there).

2) Elstein REO reflectors

The REO/250 and REO/125 reflectors are used to hold and fix the FSM, FSR, HFS/1, HSR/1, HTS/1, SHTS/1, and FSM/2, FSR/2, HFS/2, HSR/2, HTS/2 and SHTS/2 ceramic infrared heaters, and to reflect the IR radiation in the direction of the material to be heated.

They are made from polished stainless steel and have a protective foil on the inside, which must be removed before installation.

REO reflectors are part of the ready to fit EBF construction elements and the fitted REF construction sets.

They are available in the two lengths 125 mm and 250 mm.

3) Elstein MPO mounting profiles

The MPO mounting profiles are made from stainless steel and are used to hold and fix HLS and IRS series heaters.

They are available in the two lengths 125 mm and 250 mm.

4) Elstein MBO mounting sheets

The MBO mounting sheets are designed for holding and fixing ceramic infrared heaters with the dimensions 122 mm x 122 mm.

They are made from stainless steel and have a protective foil on the upper side which must be removed before installation.

MBO mounting sheets are part of the ready to fit BSI construction panels and are available in the lengths 250 mm, 375 mm and 500 mm.

5) Elstein mounting set

All ceramic infrared heaters, which have a standard Elstein socket are fixed to the reflector or mounting sheet with the help of the mounting set.

The mounting set includes a wave mounting spring and a slide, both made from stainless steel.

The scope of delivery of the heaters with a standard Elstein socket includes one mounting set for each heater.

6) Elstein fixing springs

The fixing springs are made from stainless steel and are used to fix HLS and IRS series heaters to the MPO and MPO/2 mounting profiles.

Two springs per heater are included in the scope of supply of HLS and IRS series heaters.

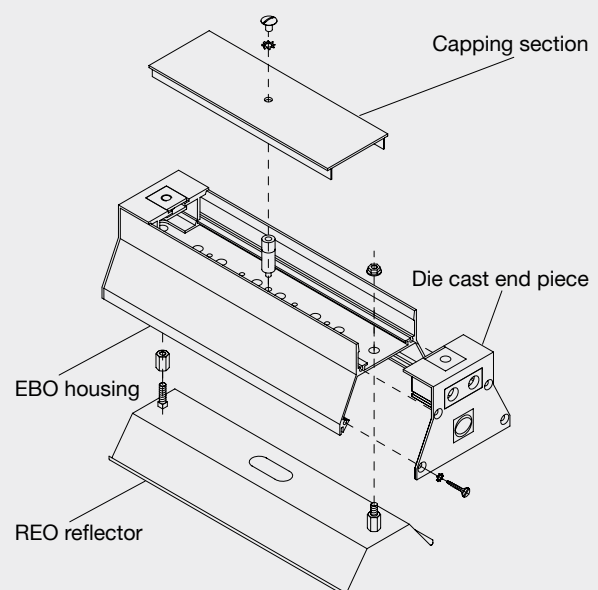
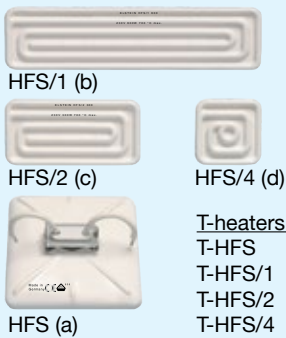

Figure 97: Example for the arrangement of metal parts using an EBO housing with REO reflector

Further Products

Further Elstein panel heaters. Technical data sheets with more detailed information are available on request or on the internet at www.elstein.com.



HFS series

a) 122 x 122 mm
b) 245 x 60 mm
c) 122 x 60 mm
d) 60 x 60 mm

60 - 600 W
230 V

max. 38.4 kW/m²
typ. up to 630 °C

Stocked items for standard wattages and voltages

T-heaters are available

T-heaters:
T-HFS
T-HFS/1
T-HFS/2
T-HFS/4

HFS (a)

Heaters of the HFS series were used for fitting the Elstein BSP construction panel. BSP is no longer available; it is replaced by BSI with HTS/HSR. The heaters of the HFS series are available however it is recommended to use the update HTS being energy saving and compatible to HFS.



FSF series

a) 122 x 122 mm
b) 245 x 60 mm
c) 122 x 60 mm
d) 60 x 60 mm

60 - 1000 W
230 V

max. 64,0 kW/m²
typ. up to 720 °C

Stocked items for standard wattages and voltages

T-heaters are available

T-heaters:
T-FSF
T-FSF/1
T-FSF/2
T-FSF/4

FSF (a)

Elstein FSF panel heaters are ceramic infrared heaters with a low overall height. Compared to other Elstein heaters with standard socket, the overall height of the FSF heaters, measured from the radiation surface up to the mounting plate, has been reduced by approximately 45 %.



HLF

122 x 122 mm

250 W 230 V
400 W 230 V
650 W 230 V

max. 41.6 kW/m²
typ. up to 630 °C

Stocked items for standard wattages and voltages

Heaters with thermocouple (T-heaters) are available (T-HLF)

Elstein HLF heaters were used for fitting the Elstein BSF construction panel. BSF is no longer available; it is replaced by BSI with HTS/HSR. The HLF heaters are available but it is recommended to use the update HTS being energy saving.



LCR

245 x 95 mm

400 W 230 V
600 W 230 V
900 W 230 V
1200 W 230 V
1500 W 230 V

max. 60.0 kW/m²
typ. up to 710 °C

Heaters with thermocouple (T-heaters) are available (T-LCR)

Elstein LCR big size heaters correspond to the concave shape of Elstein FSR, but their surface is larger by 58 %.

(Compare: The dimensions of FSR are 245 x 60 mm).



HLF/S

122 x 122 mm

250 W 230 V
400 W 230 V
650 W 230 V
800 W 230 V
1000 W 230 V

max. 64.0 kW/m²
typ. up to 720 °C

Stocked items for standard wattages and voltages

T-heaters available (T-HLF/S)

Elstein HLF/S heaters have a heightened socket and are classified between HLF and standard panel heaters (e. g. FSF, HFS, HTS). HLF/S heaters are used in heating panels or machines, which are designed for the model of HLF/S heaters; mainly in Asia.



SHTS/100

96 x 96 mm

800 W 230 V

max. 80.0 kW/m²
typ. up to 860 °C

Heaters with thermocouple (T-heaters) are available (T-SHTS/100)

The Elstein SHTS/100 super high temperature heater with the dimensions 96 x 96 mm and a surface rating of 80 kW/m² is a variant of the SHTS heater with the customary market dimensions 122 x 122 mm and a surface rating of 77 kW/m². The heaters can be mounted using the mounting carriers MTO.

Further Products

Further Elstein rod heaters and long panel heaters. Technical data sheets with more detailed information are available on request or on the internet at www.elstein.com.



ISS
 328 x 10 mm
 250 W 230 V
 400 W 230 V
 max. 48.0 kW/m²
 typ. up to 630 °C
 Heaters with thermocouple (T-heaters) are not available

Next to linear heating tasks Elstein ISS heaters are used as room, comfort or patio heater as well as heating element on terraces. The update IRS/330 can be used in already existing ISS systems. Only the holes need to be enlarged so that the bigger sockets of IRS/330 can be inserted.



IRS/330
 328 x 17 mm
 250 W 230 V
 400 W 230 V
 max. 36.4 kW/m²
 typ. up to 530 °C
 Heaters with thermocouple (T-heaters) are available (T-IRS/330)

Elstein IRS/330 rod heaters are the following model for ISS heaters. They have larger mounting sockets and the heating rod has a bigger diameter. The result is better mechanical strength and longer service life.



SBM series
 a) 460 x 20 mm
 b) 310 x 20 mm
 200 W bis 400 W
 230 V
 max. 36.0 kW/m²
 typ. up to 550 °C
 Heaters with thermocouple (T-heaters) are available (T-SBM/300 and T-SBM/450)

Elstein rod heaters SBM are used in infrared saunas.



IRS/K
 from 125 mm to 300 mm
 125 W to 750 W
 230 V
 30.0 - 75.0 kW/m²
 typ. up to 700 °C
 Heaters with thermocouple (T-heaters) are available (T-IRS/K)

The leads of Elstein IRS/K rod heaters lie only on one side. Thus IRS/K heaters make the heating of the interior of hollow bodies possible.

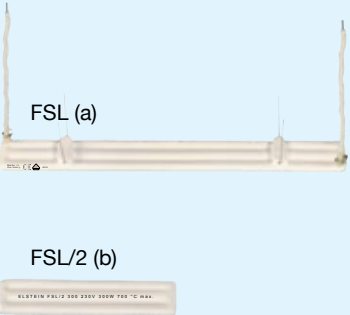

FSL
 a) 37 x 326 mm
 b) 37 x 163 mm
 600 W and 300 W
 230 V
 max. 45 kW/m²
 typ. up to 550 °C
 Stocked items for standard wattages and voltages
 T-heaters are available. (T-FSL, T-FSL/2)

Elstein FSL long panel heaters have two sockets with integrated litz fixing wires, which are put through corresponding holes in the mounting sheet and twisted behind it. No special pre-punched holders or reflector plates are required for the assembly.

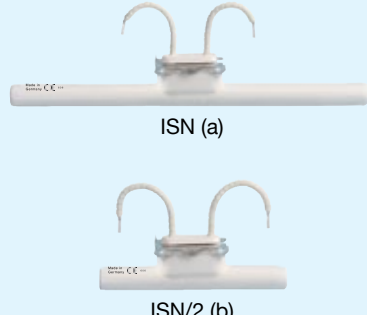

ISN series
 a) 245 x 25 mm
 b) 122 x 25 mm
 400 W 230 V
 600 W 230 V
 max. 72.0 kW/m²
 typ. up to 650 °C
 Heaters with thermocouple (T-heaters) are available (T-ISN, T-ISN/2)

Elstein ISN rod heaters are used for linear heating tasks. The heater's fixing to the mounting sheet is made using the standard socket, which also have the panel heaters like HTS series. If required an exchange between panel heater and ISN-rod heater is easily possible.

Further Products

Further Elstein screw-, round panel- and sphere heaters as well as switchboard heaters. Technical data sheets with more detailed information are available on request or on the internet at www.elstein.com.



IPO
 Ø 50 mm
 150 W 230 V
 max. 38.4 kW/m²
 typ. up to 510 °C
 Heaters with thermocouple (T-heaters) are not available

Elstein IPO heaters are especially suited for building up three dimensional heating panels.



KSS/60
 Ø 60 mm
 250 W 230 V
 max. 38.0 kW/m²
 typ. up to 670 °C
 Heaters with thermocouple (T-heaters) are available (T-KSS/60)

Elstein KSS/60 sphere heaters are a further development of IPO heaters and are especially suited for building up three dimensional heating panels. Compared to IPO they have a higher wattage, another kind of connection and can be supplied with integrated thermocouple (T-KSS/60).



IPT
 Ø 75 mm
 Ø 100 mm
 Ø 125 mm
 60 - 500 W
 max. 30,3 kW/m²
 typ. up to 510 °C
 Heaters with thermocouple (T-heaters) are not available

Elstein IPT heaters are ceramic infrared heaters with E27 screw caps.



SSH
 Ø 75 mm
 60 W 230 V
 100 W 230 V
 max. 17.6 kW/m²
 typ. up to 350 °C
 Heaters with thermocouple (T-heaters) are available (T-SSH)

Elstein SSH infrared heaters are used for switchboards in order to avoid the formation of condensation water. SSH switchboard heaters are delivered with a fixing clip, which allows an easy mounting of the SSH heater onto 35-mm standard rails.



SSV
 Ø 96 mm
 75 W
 typ. up to 200 °C
 Heaters with thermocouple (T-heaters) are not available

Elstein heaters SSV are used for vaporising sulphur in green houses.



RFS series
 Ø 125 mm
 Ø 100 mm
 150 W - 500 W
 230 V
 max. 46.2 kW/m²
 typ. up to 610 °C
 Heaters with thermocouple (T-heaters) are available (T-RFS/125 and T-RFS/100)

Elstein RFS round panel heaters enable an optimum heating of corresponding areas (for example the bottom of bottles). They are also used in small thermoform devices for dental technique.

Further Products

Further Elstein infrared systems and focus infrared heaters. Technical data sheets with more detailed information are available on request or on the internet at www.elstein.com.

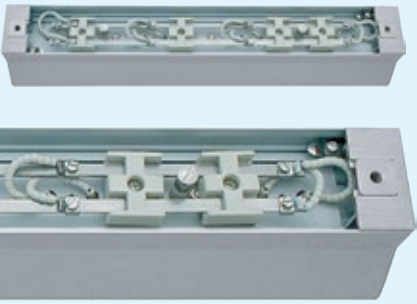

EBF-R
EBF-R/25 (cm)
in steps of 25 to
EBF-R/125 (cm)
and longer
max. 48.0 kW/m²
typ. up to 860 °C
for the heaters
(and T-heaters):
FSM, FSM/2
FSR, FSR/2
HFS/1, HFS/2
HTS/1, HTS/2
SHTS/1, SHTS/2
HSR/1, HSR/2

Elstein EBF-R construction elements correspond to the EBF system, but EBF-R is supplied in prewired condition using stainless steel power rails.



Rail wiring
AK terminal clamp, bipolar, consisting of steatite socket and stainless steel metal parts.
Stainless steel univ. power rail with 23 holes.
Total length: 1580 mm
Max. 400 V
Max. 25 A
Max. 600 °C

AK terminal clamp
Universal power rail (section)

The pictures show the delivery condition of the required materials used for rail wiring. The metal parts of the terminal clamp have to be disassembled and are used for fixing the heater's connections to the power rail. The ceramic body of the clamp is used for holding the power rail.



EBI
EBI/25 (cm)
in steps of 25 to
EBI/125 (cm)
and longer
max. 48.0 kW/m²
typ. up to 860 °C
for the heaters
(and T-heaters):
FSM, FSM/2
FSR, FSR/2
HFS/1, HFS/2
HTS/1, HTS/2
SHTS/1, SHTS/2
HSR/1, HSR/2

Elstein construction elements EBI are used for Elstein heaters with the dimensions 245x60 and 122x60 mm in order to assemble them to heating panels in various geometries. The housing parts are made from stainless steel. Construction elements EBI are available with power rails under the designation EBI-R.



EBI-R
EBI-R/25 (cm)
in steps of 25 to
EBI-R/125 (cm)
and longer
max. 48.0 kW/m²
typ. up to 860 °C
for the heaters
(and T-heaters):
FSM, FSM/2
FSR, FSR/2
HFS/1, HFS/2
HTS/1, HTS/2
SHTS/1, SHTS/2
HSR/1, HSR/2

Elstein construction elements EBI are available with power rails under the designation EBI-R.



FIS
Ø 125 mm
250 W 230 V
max. 12.3 kW/m²
typ. up to 750 °C
Stocked items for standard wattages and voltages.
Heaters with thermocouple (T-heaters) are not available

Elstein FIS focus infrared heaters are suited for solving tasks dealing with the heating of selective or small areas.



BSH
from 125x250mm to 1000x1500mm and larger
with HTS to 600W with HSR to 600W
max. 38.4 kW/m²
typ. up to 700 °C
Heaters with thermocouple are available (T-HTS, T-HSR)

Elstein BSH construction panels are used for assembling bigger sized infrared radiation areas with Elstein heaters of the HTS- or HSR series. The housing is made from aluminium. BSH is available but it is replaced by BSI, which has housing parts made from stainless steel.

Further Products

Elstein infrared heaters for room heating and infrared saunas, which are an alternative to the classical sauna. Technical data sheets with more detailed information are available on request or on the internet at www.elstein.com.

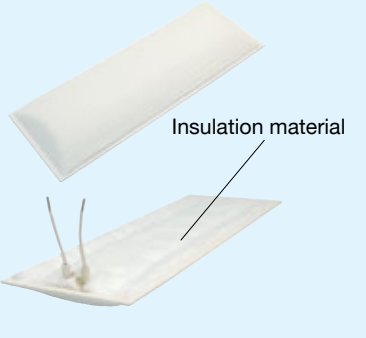

Insulation material

WKS

327 x 120 mm

200 W 230 V
250 W 230 V
600 W 230 V

Stocked items for standard wattages and voltages

Elstein WKS infrared sauna heaters are ceramic IR heaters, which fit to the requirements in IR saunas as well as room heating devices regarding material, geometry, function, design and mounting. In IR saunas heaters up to 250 W are used; room heating devices use heaters up to 600 W.



IRH

245 x 95 mm

200 W 230 V
250 W 230 V
400 W 230 V
600 W 230 V
800 W 230 V
1000 W 230 V

Stocked items for standard wattages and voltages

Elstein IRH infrared heaters are ceramic heaters in convex design. The radiating surface consists of ten small longish radiation surfaces, which are also designed in a convex shape. In IR saunas heaters up to 250 W are used; room heating devices use heaters up to 1000 W.



IRH/S

245 x 60 mm

150 W 230 V
200 W 230 V
250 W 230 V
400 W 230 V
600 W 230 V
800 W 230 V
1000 W 230 V

Stocked items for standard wattages and voltages

Elstein IRH/S infrared heaters are ceramic heaters. Their radiating surface is arranged in six small longish and convexly designed radiation surfaces. The whole radiation surface of IRH/S is also convexly designed. Like IRH these heaters are used in IR saunas as well as room heating devices.

Space for Notes

Elstein-Werk M. Steinmetz GmbH & Co. KG
Specialist Factory for Ceramic IR-Emitters
Stettiner Str. 14, 37154 Northeim
Germany

Tel.: +49 (0) 5551 983 - 0
Fax: +49 (0) 5551 983 - 61
E-Mail: info@elstein.com
Internet: www.elstein.com