

VARIAN, INC.

Spectroscopy and Dissolution Supplies

- Varian-manufactured supplies for Varian instruments deliver optimal performance
- Tested and certified spares provide consistent results
- Master complex scientific challenges with confidence



Contents

328	AA
328	Lamps
331	Graphite Supplies
332	Dispenser Supplies
334	Burners and Nebulizers
335	Spray Chambers
337	Autosampler Supplies
340	SIPS and Hydride Module Supplies
342	ICP-OES
342	Spray Chambers
343	Nebulizers
344	Torches
346	Tubing
348	Applications Kits
349	ICP-MS
349	Sample Introduction
349	Cones
350	Tubing
351	Nebulizers and Spray Chambers
352	Torches
354	UV-Vis-NIR
354	Cuvettes and Flow Cells
357	Probes
358	Lamps
359	Fluorescence
359	Cuvettes
360	Probes

Whatever the challenge, we're listening to your needs and creating innovative products to ensure your success. Count on us to roll up our sleeves and deliver a broad range of instruments and supplies to keep you up and running.

360	Lamps
361	NMR
361	Probes
361	Standard Solutions
361	Turbines
362	Rotors, Spin Modules and Starter Kits
364	Dissolution

Varian's 400-MR, with Automated Triple Broadband or AutoSwitchable probes, is ideal for analyses of compounds containing ^{19}F , such as drug precursors.





Atomic Absorption

Atomic Absorption Spectroscopy – Hollow Cathode Lamps

Varian hollow cathode lamps provide optimum signal to noise performance, permitting determinations at even lower levels with the most demanding applications. We manufacture our lamps and instruments in the same factory, so they are optimized to deliver the best performance from your AA. Varian lamps provide high spectral purity because of purified materials, extended processing cycle and factory lamp conditioning procedures. These ensure minimal lamp warm-up time and good stability during operation.

Economical operation is assured by the long lamp life, guaranteed to 5000 mA hours but typically exceeding 8000 mA hours, over and above Varian's factory preconditioning and testing service.



Consistent performance is also assured. All lamps are tested to confirm that the emission intensity exceeds a minimum level and that the lamp provides good signal to noise and stability. No lamp leaves our factory without having satisfied our demanding test standards. These tests ensure that you receive quality lamps that can provide optimum signal to noise and stable performance throughout the life of the lamp.

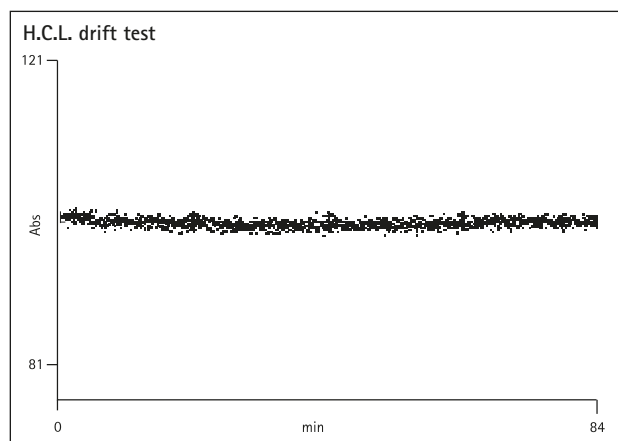

The trace shows the variation in emission intensity from a lamp over 1 hour 24 minutes. The steady trace demonstrates the superb stability and low drift achieved when using Varian hollow cathode lamps (after a suitable warm-up period).

High Intensity UltrAA Lamps Coded Single Element: For Superior Performance

- Emission intensity is increased by 3-5 times, for lower noise
- Sensitivity is increased by up to 40%, due to the sharper emission profile, allowing determinations at even lower levels
- Element coded for automatic lamp recognition, preventing errors if the wrong lamp position is entered

Varian UltrAA lamps are high intensity boosted discharge hollow cathode lamps. They use the standard lamp current, but apply an additional boost discharge within the lamp to increase the emission intensity. The boost current is supplied from a secondary control module (either integrated into the instrument or supplied from an external module).

UltrAA lamps are manufactured from the purest cathode materials, and every lamp is QA/QC tested to guarantee performance and reliability. These lamps are coded for automatic lamp recognition (except for SpectrAA-50/55 and SpectrAA-5 models), so there is no need for the user to waste time reprogramming the lamp position when the lamp is moved. This eliminates time consuming errors.

Ordering Information

Element	Part No.
Antimony – Sb	5610108000
Arsenic – As	5610108100
Bismuth – Bi	5610134200
Boron – B	5610135700
Cobalt – Co	5610134100
Copper – Cu	5610109100
Germanium – Ge	5610134300
Gold – Au	5610109000
Iron – Fe	5610108600
Lead – Pb	5610108200
Manganese – Mn	5610133700
Nickel – Ni	5610108500
Palladium – Pd	5610135800
Platinum – Pt	5610135900
Selenium – Se	5610108300
Silicon – Si	5610133400
Tellurium – Te	5610134000
Thallium – Tl	5610108400
Tin – Sn	5610133900



Atomic Absorption

High Intensity UltraAA Lamps Coded Multi-Element: Light From Many Elements in One Lamp

- Unique combinations of compatible elements extend the versatility and performance of any AA spectrometer
- Avoid the need to warm up a new lamp and save time
- Same excellent performance as provided by Varian single element lamps

Ordering Information

Elements	Part No.
Aluminium/ Calcium/ Magnesium – Al/Ca/Mg	5610133600
Cobalt/ Chromium/ Copper/ Iron/ Manganese/ Nickel – Co/Cr/Cu/Fe/Mn/Ni	5610134500
Cobalt/ Molybdenum/ Lead/ Zinc – Co/Mo/Pb/Zn	5610135200
Copper/ Iron/ Manganese/ Zinc – Cu/Fe/Mn/Zn	5610135000
Copper/ Iron/ Silicon/ Zinc – Cu/Fe/Si/Zn	5610135100
Copper/ Zinc – Cu/Zn	5610134600
Silver/ Cadmium/ Lead/ Zinc – Ag/Cd/Pb/Zn	5610108900
Silver/ Chromium/ Copper/ Iron/ Nickel – Ag/Cr/Cu/Fe/Ni	5610134900

High Intensity UltraAA Lamps Uncoded Multi-Element: Excellent Value for Money

Ordering Information

Elements	Part No.
Arsenic/ Copper/ Iron – As/Cu/Fe	5610135300
Nickel/ Selenium – Ni/Se	5610135400

Background Correction Lamps: Fast and Accurate Correction

Varian-approved deuterium background correction lamps provide accurate and fast correction over the widest possible absorbance range and are QC-selected for optimum lifetime.

Ordering Information

Description	Part No.
Deuterium (D ₂) Background Correction Lamp for Varian AA	5610021800

Hollow Cathode Lamps Coded Single Element: For All AAs Using Octal Base Lamps

- Manufactured from the purest cathode materials for high performance
- Coded lamps make AA easier and more flexible, and improve productivity
- Lamps are non-hazardous, and non-reactive if unbroken, for safe operation

Ordering Information

Element	Part No.	Element	Part No.
Aluminium – Al	5610100100	Neodymium – Nd	5610103600
Antimony – Sb	5610100200	Nickel – Ni	5610103700
Arsenic – As	5610100300	Niobium – Nb	5610103800
Barium – Ba	5610100400	Osmium – Os	5610103900
Beryllium – Be	5610100500	Palladium – Pd	5610104000
Bismuth – Bi	5610100600	Phosphorus – P	5610107700
Boron – B	5610100700	Platinum – Pt	5610104100
Cadmium – Cd	5610100800	Potassium – K	5610104200
Calcium – Ca	5610101000	Praseodymium – Pr	5610104300
Cerium – Ce	5610101100	Rhenium – Re	5610104400
Cesium – Cs	5610100900	Rhodium – Rh	5610104500
Chromium – Cr	5610101200	Rubidium – Rb	5610104600
Cobalt – Co	5610101300	Ruthenium – Ru	5610104700
Copper – Cu	5610101400	Samarium – Sa	5610104800
Dysprosium – Dy	5610101500	Scandium – Sc	5610104900
Erbium – Er	5610101600	Selenium – Se	5610105000
Europium – Eu	5610101700	Silicon – Si	5610105100
Gadolinium – Gd	5610101800	Silver – Ag	5610105200
Gallium – Ga	5610101900	Sodium – Na	5610105300
Germanium – Ge	5610102000	Strontium – Sr	5610105400
Gold – Au	5610102100	Tantalum – Ta	5610105500
Hafnium – Hf	5610102200	Tellurium – Te	5610105600
Holmium – Ho	5610102300	Terbium – Tb	5610105700
Indium – In	5610102500	Thallium – Tl	5610105800
Iridium – Ir	5610102600	Thulium – Tm	5610106000
Iron – Fe	5610102700	Tin – Sn	5610106100
Lanthanum – La	5610102800	Titanium – Ti	5610106200
Lead – Pb	5610102900	Tungsten – W	5610106300
Lithium – Li	5610103000	Vanadium – V	5610106500
Lutetium – Lu	5610103100	Ytterbium – Yb	5610106600
Magnesium – Mg	5610103200	Yttrium – Y	5610106700
Manganese – Mn	5610103300	Zinc – Zn	5610106800
Mercury – Hg	5610103400	Zirconium – Zr	5610106900
Molybdenum – Mo	5610103500		

SUPPLIES



Atomic Absorption

Hollow Cathode Lamps Uncoded Single Element: Economical for Everyday Use

Ordering Information

Element	Part No.	Element	Part No.
Aluminium – Al	5610122000	Neodymium – Nd	5610125500
Antimony – Sb	5610122100	Nickel – Ni	5610125600
Arsenic – As	5610122200	Niobium – Nb	5610125700
Barium – Ba	5610122300	Osmium – Os	5610125800
Beryllium – Be	5610122400	Palladium – Pd	5610125900
Bismuth – Bi	5610122500	Phosphorus – P	5610126000
Boron – B	5610122600	Platinum – Pt	5610126100
Cadmium – Cd	5610122700	Potassium – K	5610126200
Calcium – Ca	5610122900	Praseodymium – Pr	5610126300
Cerium – Ce	5610123000	Rhenium – Re	5610126400
Cesium – Cs	5610122800	Rhodium – Rh	5610126500
Chromium – Cr	5610123100	Rubidium – Rb	5610126600
Cobalt – Co	5610123200	Ruthenium – Ru	5610126700
Copper – Cu	5610123300	Samarium – Sm	5610126800
Dysprosium – Dy	5610123400	Scandium – Sc	5610126900
Erbium – Er	5610123500	Selenium – Se	5610127000
Europium – Eu	5610123600	Silicon – Si	5610127100
Gadolinium – Gd	5610123700	Silver – Ag	5610127200
Gallium – Ga	5610123800	Sodium – Na	5610127300
Germanium – Ge	5610123900	Strontium – Sr	5610127400
Gold – Au	5610124000	Tantalum – Ta	5610127500
Hafnium – Hf	5610124100	Tellurium – Te	5610127600
Holmium – Ho	5610124200	Terbium – Tb	5610127700
Indium – In	5610124400	Thallium – Tl	5610127800
Iridium – Ir	5610124500	Thulium – Tm	5610128000
Iron – Fe	5610124600	Tin – Sn	5610128100
Lanthanum – La	5610124700	Titanium – Ti	5610128200
Lead – Pb	5610124800	Tungsten – W	5610128300
Lithium – Li	5610124900	Vanadium – V	5610128500
Lutetium – Lu	5610125000	Ytterbium – Yb	5610128600
Magnesium – Mg	5610125100	Yttrium – Y	5610128700
Manganese – Mn	5610125200	Zinc – Zn	5610128800
Mercury – Hg	5610125300	Zirconium – Zr	5610128900
Molybdenum – Mo	5610125400		

Hollow Cathode Lamps Coded Multi-Element: Unique Element Combinations to Extend AA Versatility

- All usual primary lines checked to avoid and minimize spectral interferences
- Avoid the need to warm up a new lamp and save time
- Same excellent performance as provided by Varian single element lamps

If secondary lines are needed then the Varian UltraAA lamps with their high intensity boosted discharge, can help to minimize any interferences.

Ordering Information

Elements	Part No.
Aluminium/ Calcium/ Magnesium – Al/Ca/Mg	5610108800
Calcium/ Magnesium – Ca/Mg	5610107100
Cobalt/ Chromium/ Copper/ Iron/ Manganese/ Nickel – Co/Cr/Cu/Fe/Mn/Ni	5610107600
Cobalt/ Molybdenum/ Lead/ Zinc – Co/ Mo/ Pb/ Zn	5610109800
Copper/ Iron/ Manganese/ Zinc – Cu/Fe/Mn/Zn	5610109600
Copper/ Iron/ Silicon/ Zinc – Cu/Fe/Si/Zn	5610109700
Copper/ Zinc – Cu/Zn	5610119200
Silver/ Cadmium/ Lead/ Zinc – Ag/Cd/Pb/Zn	5610108700
Silver/ Chromium/ Copper/ Iron/ Nickel – Ag/Cr/Cu/ Fe/Ni	5610109500
Sodium/ Potassium – Na/K	5610107000

Hollow Cathode Lamps Uncoded Multi-Element: Economical Element Combinations to Maximize Operating Budgets

Ordering Information

Elements	Part No.
Barium/ Chromium – Ba/Cr	5610133500
Calcium/ Magnesium – Ca/Mg	5610129100
Cobalt/ Chromium/ Copper/ Iron/ Manganese/ Nickel – Co/Cr/Cu /Fe/Mn/Ni	5610129200
Copper/ Zinc – Cu/Zn	5610129300
Sodium/ Potassium – Na/K	5610129000



Atomic Absorption

Graphite Furnace Operating Kits: For Varian GTA Furnace Systems

Maximize your AA uptime by keeping one of these kits handy.

The kit for moderate use of the Varian GTA120 Furnace System (including Zeeman systems) contains:

2 Packs Graphite Electrodes (2/pk) (either 6310003500 Zeeman electrodes or 6310003400 normal electrodes)

Graphite Shroud (either 6310003600 Zeeman shroud or 6310003100 normal shroud)

5 Packs Partitioned Tubes (6310002300) for use with Forked Platforms (10/pk)

5 Packs Forked Pyrolytic Graphite Platforms (6310002400) (10/pk)
100 µL Syringe, PSD (4710003200)

1 Pack Capillary Assembly, PSD120 (9910115100) (5/pk)

1 Pack Beakers, PSD, (6610008200) (5/pk)

2 Packs Vials 2 mL, PSD (9910028200) (1000/pk)

Ordering Information

Description	Part No.
GTA120 Deuterium Furnace Operating Supplies Kit	190067900
GTA120 Zeeman Furnace Operating Supplies Kit	190068000

The kit for moderate use of the Varian GTA-100/110 Furnace Systems (including Zeeman systems) contains:

2 Packs Graphite Electrodes (either 6310001700 Zeeman electrodes or 6310001600 normal electrodes) (2/pk)

5 Packs Partitioned Tubes (6310002300) (for use with Forked Platforms) (10/pk)

5 Packs Forked Pyrolytic Graphite Platforms (6310002400) (10/pk)
100 µL Syringe, PSD (4710002300)

Plunger for 100 µL syringe (4710003100)

1 Pack Capillary Assembly, PSD (9910032300) (5/pk)

1 Pack Beakers, PSD (6610008200) (5/pk)

2 Packs Vials 2 mL, PSD (9910028200) (1000/pk)

Ordering Information

Description	Part No.
GTA-100/110 Deuterium Furnace Operating Supplies Kit	190024900
GTA-100/110 Zeeman Furnace Operating Supplies Kit	190025000

Graphite Tubes and Platforms: Superior Performance, Even With Difficult Samples

- High purity graphite reduces spurious absorption from trace contaminants and improves signal to noise
- Every tube is hand checked for reproducible and reliable results
- Productivity increases because you perform fewer repeats

Genuine Varian graphite tubes are quality tested to ensure each batch passes our demanding performance specifications. Our tubes are tested for contamination, sensitivity, precision, electrical resistance and lifetime.

Omega Platform Tubes combine ease-of-use with perfect atomization: the integrated platform ensures the perfect thermal profile to produce dense atom clouds for good signal to noise ratios and the best detection limits.

Platforms prevent premature atomization of volatile elements such as lead, selenium or arsenic. Omega tubes with an integrated platform can be used straightaway, while notched platforms provide continuity with older methods.

Use partitioned tubes for general purpose work or multiple elements.

Ordering Information

(10/pk)

Description	Part No.	
Omega Platform Tubes, Pyrolytically Coated	6310003700	
Solid Pyrolytic Graphite Platforms (only for plateau tubes 6310001100)	6310001300	
Plateau Tubes, Pyrolytically Coated (only for pyrolytic platforms 6310001300)	6310001100	
Partitioned Tubes, Pyrolytically Coated	6310001200	



Atomic Absorption

Graphite Electrodes: For all Graphite Tube Atomizers

- Spare electrodes maximize uptime
- Good electrical contact ensures optimum performance
- Good electrical contact maximizes tube life

Ordering Information

(2/pk)

Description	Part No.	
Kit Graphite Electrodes for GTA120	6310003400	
Kit Graphite Electrodes for GTA120 Zeeman	6310003500	
Kit Graphite Electrodes for GTA-95/96/97/100/110	6310001600	
Kit Zeeman Graphite Electrodes for GTA-96/100/110 Zeeman	6310001700	

Graphite Shrouds: Protective Shroud for Graphite Tube Atomizers

Ordering Information

Description	Part No.	
Graphite Shroud for GTA120	6310003100	
Graphite Shroud for GTA120 Zeeman	6310003600	
Graphite Shroud for GTA-95/96/97/100/110	6310001800	
Graphite Shroud for GTA-96/100/110 Zeeman	6310001900	

Graphite Furnace Tools

Ordering Information

Description	Part No.	
Electrode Extractor Tool for GTA-96/97/100/110/120 (2 draw bars)	9910031200	
Shroud Removal Tool for GTA-96/97/100/110/120	9910033300	
Zeeman Electrode Extractor Tool for GTA-96/100/110/120 Zeeman (2 draw bars)	9910049300	
Zeeman Shroud Removal for GTA-96/100/110/120 Zeeman	9910050400	

Programmable Sampler Dispenser Supplies

Ordering Information

Spares and consumables for programmable sample dispensers (PSD) for graphite furnace AAS.

Description	Part No.	
Sample Vials 1.1 mL, Polyethylene (for use with PSD120 high capacity sample carousel (2000/pk))	6610025900	
Sample Vials 2 mL Conical Polyethylene (1000/pk)	9910028200	
Glass Beakers 25 mL for PSD-95/96/97/100 (5/pk)	6610008200	



Atomic Absorption





Ordering Information

Spares and consumables for programmable sample dispensers (PSD) for graphite furnace AAS continued



Description	Part No.	
Plastic Beakers 10 mL for PSD120 High Capacity Carousel (5/pk)	9910115600	
Rinse Bottle, Nalgene™, 1 L for PSD-97/100/120	6610012100	
Cap for Rinse Bottle PSD-97/100/120	1610094600	
Capillary Assembly for PSD120 (5/pk)	9910115100	
Capillary Assembly for PSD-95/96/97/100 (5/pk)	9910032300	
Carousel Adaptors. (Allows use of 2 mL sample vials in the central carousel locations. For PSD-96/97/100 (5/pk))	9910054200	
Syringe, 100 µL for PSD120 Only	4710003200	
Syringe, 100 µL for PSD-95/96/97/100	4710002300	
Plunger for 100 µL Syringe, Teflon® Tipped	4710003100	
Replacement Carousel Plate for PSD-100/120	5410029700	

Ordering Information

Spares and consumables for programmable sample dispensers (PSD) for graphite furnace AAS continued

Description	Part No.	
Replacement Carousel Plate for PSD-96/97	5410019900	
Replacement Carousel Plate for 130 Sample Carousel for PSD120 only	5410046300	
Capillary Viewing Mirror for GTA-110/120	9910091200	
Capillary Viewing Mirror Kit for GTA-96/97/100	9910032700	

Optional accessories for programmable sample dispensers (PSD) for graphite furnace AAS.

Description	Part No.	
GTA Viewing and Fume Extraction Accessory for GTA120. (Mounts on sample compartment to remove fumes from the GTA workhead and improves viewing of the tube for easier alignment. Connects to a 150 mm (6 in.) or 125 mm (5 in.) exhaust duct).	210190000	
High Capacity Carousel Kit for GTA120 Only (with carousel disk (130 samples), 1.1 mL vials (2000/pk) and five containers for bulk solutions)	9910113100	
Bubble Free Syringe Update Kit for PSD-97/100	9910116800	

SUPPLIES





Atomic Absorption

Burners and Nebulizers: Contoured Design Minimizes Burner Blockage

The Mark 7 burner fits all current Varian AA instruments and the earlier SpectrAA series instruments. It is compatible with the Mark V, VI and 7 spray chambers.

Ordering Information

Description	Part No.	
Mark 7 Air/ Acetylene Burner	210164000	
Mark 7 Nitrous Oxide/ Acetylene Burner	210164100	
Burner Cleaner Strips (100/pk)	9910053900	



Nebulizer Maintenance

Ordering Information

Description	Part No.	
Spare Tantalum Venturi Kit for Mark V and VI Spray Chambers	9910024400	
Pt/Ir Capillary Spares Kit, Hi-Vac and Non-Hi-Vac	9910024500	
High Solids Capillary Tubing (3 m)	9910024800	
1 Pack High Vacuum Capillary Tubing (3/pk)	9910044000	
Nebulizer Capillary Kit, Mark 7 Atomization System	9910093000	
Nebulizer Cleaning Wire (3 x 0.9 m lengths)	9910024700	
Nebulizer O-Ring Kit	9910035200	

Nebulizers for Mark V and VI Spray Chambers

Ordering Information

Description	Part No.	
Barrel Nebulizer, Adjustable	9910043500	
Barrel Nebulizer, Hi-Vac	9910043700	



Atomic Absorption

Mark 7 Flame Atomization System Operating Kit: All You Need for Typical Operation

Typical operation supplies required for moderate use of Varian Flame Atomic Absorption Spectrometer Systems with Mark 7 spray chamber.

The kit contains:

- PEEK™ Venturi (1610117390)
- Pt/Ir Capillary Kit (9910093000)
- Nebulizer Block Kit (9910093100)
- 1 Pack Glass Impact Beads (9910025700) (5/pk)
- Capillary Tubing, Standard Nebulizer (9910024800)
- O-Ring Kit Mark 7, Aqueous (9910093400)
- 1 Pack Mixer Paddle Mark 7, fluorinated (9910093600) (5/pk)
- 1 Pack Burner Cleaning Strips (9910053900) (100/pk)

Mark 7 Spray Chambers: Inert Design for Organic and Aqueous Use

- Fit organic resistant O-rings to ensure organic compatibility
- Simple-to-use twist and lock assembly makes for easy cleaning and routine maintenance
- Flexible operation with the capability to tune performance using the externally adjustable impact bead, fit mixing paddles for better precision, or both

This spray chamber has inert construction making it suitable for use with aqueous and organics solutions.

Ordering Information

Mark 7 spray chambers

Description	Part No.	
Nebulizer Capillary Kit	9910093000	
1 Pack Glass Impact Beads (5/pk)	9910025700	
1 Pack Mixing Paddles, Fluorinated (5/pk)	9910093600	
O-ring Kit for Aqueous Samples	9910093400	
O-ring Kit for Organic Samples	9910093500	
Nebulizer Block (including integrated nebulizer)	9910093100	
Kit, Fluorinated Liquid Trap, Float and Magnet	9910105800	
Drain Tubing for Aqueous Solutions Per Metre (2 m length required)	3710009200	

Ordering Information

Description	Part No.
Mark 7 Operating Supplies Kit	190034100

SUPPLIES



Atomic Absorption

Ordering Information

Mark 7 spray chambers continued

Description	Part No.	
Pressure Relief Bung, Fluorinated	1610118800	
Spray Chamber Body, Fluorinated	6210092000	
Tool, Venturi Extraction	7210027700	
Tool, Nebulizer Capillary Extraction	7210027600	
Complete Mark 7 Spray Chamber Assembly	110634490	

Mark VI Spray Chambers

The Mark VI spray chamber was used with older model Varian instruments. It has many of the design features and benefits of the Mark 7 design. There are two versions of the Mark VI – the standard version for normal aqueous samples and the Universal version for use with organic samples.

Ordering Information

Description	Part No.	
O-Ring/Gasket Kit	9910026500	
Mixing Paddles (5/pk)	9910063600	
Liquid Trap and Float Assembly	110315690	
Drain Tubing for Aqueous Solutions Per Meter (2 m length required)	3710009200	
Nebulizer Bung Assembly (requires nebulizer)	110351990	
Pressure Relief Bung	1610050190	
Spray Chamber Assembly, Complete (requires nebulizer)	110351790	

Mark VI Flame Atomization System Operating Kit

Typical operation supplies required for moderate use of Varian Flame Atomic Absorption Spectrometer Systems with the Mark VI spray chamber (with aqueous samples).

The kit contains:

- Tantalum Venturi Kit (9910024400)
- Pt/Ir Capillary Kit (9910024500)
- Nebulizer, Fixed Uptake (9910043700)
- Nebulizer O-Ring Kit (9910035200)
- 1 Pack Capillary Tubing, High Vacuum (9910044000) (3/pk)
- Spray Chamber O-Ring Kit (9910026500)
- 1 Pack Mixer Paddles, Universal Mark VI (9910063600) (5/pk)
- 1 Pack Burner Cleaning Strips (9910053900) (100/pk)

Ordering Information

Description	Part No.
Mark VI Operating Supplies Kit	190024800



Atomic Absorption



Mark VI Universal Spray Chamber

Ordering Information

Description	Part No.	
O-Ring/Gasket Kit	9910045700	
Mixing Paddles (5/pk)	9910063600	
Liquid Trap and Float Assembly	9910061600	
Nebulizer Bung Assembly (requires nebulizer)	9910063200	
Pressure Relief Bung	9910063100	
Drain Tubing for Organic Solvents, Nitrile Rubber Per Meter (2 m length required)	3710011700	
Universal Spray Chamber and Liquid Trap Assembly Complete (requires nebulizer)	9910061100	

Impact Beads

Ordering information

Description	Part No.	
Glass Impact Beads, Mark V/VI/7 Spray Chambers (5/pk)	9910025700	
Glass Impact Beads, Mark IV Spray Chamber (5/pk)	9910021300	
PTFE Impact Beads, Mark V/VI/7 Spray Chambers (5/pk)	9910053300	

SPS3 Autosampler Supplies

- Varian's fastest spectroscopy autosampler for high throughput analytical laboratories
- Productivity boosting features decrease analysis times
- Customizable to improve quality of results and reduce running costs

SPS3 Start-up and Operating Supplies Kit



Typical start up and operating supplies required for moderate use of Varian SPS3.

The kit contains:

- 1 ea. PTFE Sleeved Probe, 0.8 mm ID (9910111900)
- 2 pk/12 Pump Tubes - 3 Bridged, Gray/Gray (3710049000)
- 1ea. Silicon Joining Tubing Kit (3710026400)
- 2 ea. Nalgene™ Drain Tubing (3710031500)
- 2 ea. Polyethylene Capillary Tubing (2410020500)
- 1 ea. Rinse Reservoir (6610011800)
- 1 case/1000 Polypropylene Sample Tubes, 16 x 125 mm (190049700)
- 3 ea. SPS Rack - 21 Tubes (30 mm Diameter) (6610026600)
- 1 case/500 Polypropylene Sample Tubes, 50 mL (190065200)

Ordering Information

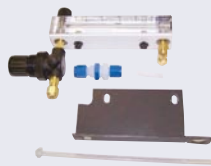
Optional accessories for SPS3

Description	Part No.	
Autosampler Cover. (This transparent cover prevents contamination of samples and standards from dust and drafts. The cover has provision for an optional purge connection and/or an exhaust outlet to enable removal of corrosive or solvent fumes.)	910245400	
Internal Purge Kit. (Includes all components required to purge the inside of the cover with inert gas (e.g. for trace level ICP-MS applications). Includes flow meter, regulator, tubing and instructions.)	9910120200	
Exhaust Port Connection. (Installs on the rear panel of the cover and allows the safe removal of corrosive or solvent fumes. Suitable for connection to 2 in. (50 mm) diameter exhaust ducting.)	9910130600	

SUPPLIES



Atomic Absorption

Ordering Information

Supplies kit

Description	Part No.
SPS3 Start Up and Operating Supplies Kit	190065400

Test tubes

Description	Quantity/ Case	Part No.
Polypropylene Tubes, 16 mm OD	125	3710051100
	1000	190049700
Glass Test Tubes, 18 mm OD	500	190049800



Digestion caps

Description	Part No.
Centrifuge Tubes, Screw Capped, 30 mm OD, 50 mL Polyethylene	190047900

Probes

Description	Part No.
0.8 mm ID Inert Probe, PTFE Sleeved for Use with AA Instruments (without Diluter)	9910111900
1.0 mm ID Inert Probe, PTFE Sleeved for Use with Diluter	9910112000
1.3 mm ID Inert Probe, PTFE Sleeved	9910130900

Sample racks

Description	Part No.
Sample Rack for 13 mm OD Tubes, 90 Positions	6610026400
Sample Rack for 16 mm OD Tubes, 60 Positions	6610025400
Sample Rack for 20 mm OD Tubes, 40 Positions	6610025500
Sample Rack for 25 mm OD Tubes, 24 Positions	6610026500
Sample Rack for 30 mm OD Tubes, 21 Positions	6610026600



Spare standards racks

Description	Part No.
11 Position Standards Rack for 16 mm OD Tubes	810166900
6 Position Standards Rack for 29 mm OD Tubes	810167000



Ordering Information

Rack overlays for sample racks

Description	Part No.
Rack Overlay Kit for 16 mm OD Tube Rack. (Allows 60, 13 mm OD tubes to be used in the rack.)	6610026100
Rack Overlay Kit for 20 mm OD Tube Rack. (Allows 40, 18 mm OD tubes to be used in the rack.)	6610026000



Diluter spares

Description	Part No.
Tubing Kit, Syringe to Valve	9910062700
Replacement Kit for All Diluter Tubes and Connectors	9910083100
Diluent Reservoir (12 L) for Diluter	6610011800



Tubing and miscellaneous items

Description	Part No.
Nalgene™ Tubing, 1/8 in. ID x 1/4 in. OD, for Outlet Rinse Vessel, Per m	3710031500
Pump Tubing for AA, ICP-OES and ICP-MS Instruments, 3 Bridged, Gray/Gray (12/pk)	3710049000
Pump Tubing for UV/Vis Instruments, 3 Bridged, Purple/Black (12/pk)	3710052000
Silicon Tubing, 1 mm ID, for Connecting RSA to Autosampler and/or Flow Cells, per m	3710026400
Replacement Spill Tray	6610025100





Atomic Absorption

SPS-5 Operating Supplies Kit

Typical operating supplies required for moderate use of Varian SPS-5 and Diluter.

The kit contains:

- 2 ea. Probe Assembly 1 mm ID (screw fitting) (210148600)
- 2 ea. Tubing Kit, Syringe to Valve (screw fitting) (9910083500)
- 2 ea. Tubing Kit, Auto Diluter (screw fitting) (9910083100)
- 1 ea. Storage Coil Assembly (screw fitting) (110594690)

Ordering Information

Description	Part No.
SPS-5 and Diluter Operating Supplies Kit	190025300

Test tubes and bottles



Description	Part No.
Glass Vessels for Rack Type A, 12 x 150 mL	9910058500
High Density Polyethylene Bottles for Rack Type B, 6 x 500 mL	9910058600
Rinse Reservoir, 10 L	6610011800

Probes

Description	Part No.
Inert Sample Probe with 1.0 mm ID Tubing and Plug Fitting	210138000
Inert Sample Probe with 1.0 mm ID Tubing and Screw Fitting	210148600
Inert Sample Probe with 2.0 mm ID Tubing and Plug Fitting	210138100
Inert Sample Probe with 2.0 mm ID Tubing and Screw Fitting	210148700
Spare Inert Sample Probes (2) with 1 m of PTFE Inner Tubing and Connector	210128200

SPS-5 Diluter Maintenance

Ordering Information

Description	Part No.
Syringe, 20 mL	4710003000 
Syringe-to-Valve Tube Kit	9910062700
Replacement Tubing Kit for Auto Diluter, Bung Fittings. (Includes all tubing and connectors.)	9910059100 
Replacement Tubing Kit for Auto Diluter, Screw Fittings. (Includes all tubing and connectors.)	9910083100

Racks and Covers

A range of inert polypropylene sample racks is available for the SPS-5. Each rack includes the Magnetic Rack Recognition feature.

Ordering Information

Description	Part No.
SPS-5 Rear Rack	110427100
Extension Option (Platform mounts on the SPS-5 to extend total capacity to five racks.)	
SPS-5 Sample Rack Type 10 = 100 x 10 mL, 13 mm OD	210127300 
SPS-5 Sample Rack Type 25 = 60 x 25 mL, 19 mm OD	210127200
SPS-5 Sample Rack Type 50 = 35 x 50 mL, 25 mm OD	210127100
SPS-5 Sample Rack, Type A = 12 x 150 mL, 40 mm OD (Includes glass vessels.)	210126800
SPS-5 Sample Rack, Type B = 6 x 500 mL, 72 x 72 mm OD (Includes polypropylene vessels.)	210126900
Rack Overlay Kit for Type 25 Racks (Allows 17 mm OD tubes to be secured in the rack. Includes two plastic overlays, four plastic inserts to secure onto rack.)	9910083700 
Rack Overlay Kit for Type 25 Racks. (Allows 18.5 mm OD tubes to be secured in the rack. Includes two plastic overlays, four plastic inserts to secure onto rack.)	9910083800

SUPPLIES



Atomic Absorption

SIPS-10/20 Supplies: Eliminate Manual Standard Preparation

The Sample Introduction Pump System (SIPS) is an innovative sample introduction and dilution system for flame AA that eliminates the task of manual preparation of multiple calibration standards, and provides fast, accurate on-line dilution of over range samples.

Typical operating supplies required for moderate use of SIPS-10/20.

The Operating Supplies Kit - G contains:

- 2 ea. 500 mL Constant Pressure Bottle (110533590)
- 1 ea. 1 L Diluent Bottle (6610014600)
- 1 ea. SIPS 3-Way Tee Piece Assembly (for SIPS-20) (110585790)
- 1 Pack SIPS Pump Tubing (6/pk) (9910075900)
- 1 ea. SIPS Tubing Kit (9910076100)
- 1 Pack SIPS Pump Bands (10/pk) (9910077600)

Ordering Information

Description	Part No.
Kit - G, SIPS 10/20 Operating Supplies Kit	190025400

SIPS-10/20 Maintenance

Ordering Information

Description	Part No.
SIPS-10/20 Pump Tubing (6/pk)	9910075900
Tubing Kit, to Connect Mariotte Bottle to Tee Piece	9910076100
Constant Pressure Head Bottle, Rectangular, 1 L	110766690
Constant Pressure Head Bottle, Rectangular, 500 mL	110533590
Pump Bands (10/pk)	9910077600
SIPS-10 2-Way Tee Piece Assembly	110651090
SIPS-20 3-Way Tee Piece Assembly	110585790



Hydride Modules: Ideal for ppb Level Vapor Generation Determinations

The Vapor Generation Accessory (VGA-77) is ideal for parts per billion determination of Hg and the hydride-forming elements.

Typical operating supplies required for moderate use of Varian VGA-77 Atomic Absorption Accessory.

The VGA-77 Operating Supplies Kit contains:

- 2 ea. Tubing and Connector Kit, VGA-77 (9910061900)
- 2 Packs Pump Tubes, Black/Black, 12/pk (3710027200)
- 2 Packs Pump Tubes, Purple/Purple, 12/pk (3710027300)
- 1 ea. Kit, Pump Beads (9910050700)
- 1 ea. Glass Liquid Separator, VGA-77 (9910071100)
- 1 ea. Mercury Flow-through Cell (9910040700)
- 2 Boxes Hydride Absorption Cells, 2/box (9910040000)
- 1 ea. Spare Plumbing Module, VGA-77 (9910062100)

Ordering Information

VGA-77 operating supplies kit

Description	Part No.
VGA-77 Operating Supplies Kit	190025200

Hydride modules

Description	Part No.
AA Hydride Module VGA-77	9910062100
ICP Hydride Module VGA-77P	9910062200



Absorption cells

Description	Part No.
Flow Through Mercury Absorption Cell for VGA-76/77 (Single cell)	9910040700
Hydride Absorption Cells VGA-76/77, Quartz (2/pk)	9910040000

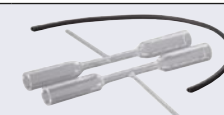









Atomic Absorption

Ordering Information

Tubing



Description	Part No	
Reagent Pump Tubing for VGA-76/77, Black/Black (12/pk)	3710027200	
Sample Pump Tubing for VGA-76/77, Purple/Black (12/pk)	3710027300	
Tubing and Connector Kit, VGA-77	9910061900	
Tubing Kit for VGA-77	9910083400	
Tubing VGA-76/77, Gas Liquid Separator to Absorption Cell	3710026390	
Tubing and Connector Kit, VGA-76	9910039900	

Gas-liquid separators

Description	Part No.	
Gas-Liquid Separator VGA-77 for AA	9910071100	
Gas-Liquid Separator VGA-77P for ICP	9910062000	
Gas-Liquid Separator VGA-76	9910040200	

Ordering Information

VGA-76/77 maintenance

Description	Part No	
Pump Tube Beds Kit, VGA-76/77	9910050700	
VGA Cell Support for Mark 7 Burner	110654990	
VGA Cell Support for Mark VI Burner	110375990	



ICP-OES

Varian's range of simultaneous ICP-OES systems provide the ultimate in productivity, flexibility and sensitivity and are designed to satisfy every application requirement.

ICP-OES Spray Chambers and Brackets: For All Applications

- **Single pass glass cyclonic spray chamber for good signal to noise performance with excellent washout**
- **Double pass glass cyclonic spray chamber provides improved plasma stability with organic and high TDS samples**
- **Sturman-Masters spray chamber is inert and minimizes interferences, and improves stability with high TDS samples**

Ordering Information

ICP-OES spray chambers and brackets

Description	Part No.	
Single-pass, Glass Cyclonic Spray Chamber for Axial ICP-OES (needs mounting bracket)	2010081700	
Double-pass, Glass Cyclonic Spray Chamber Suitable for all ICP-OES (needs mounting bracket)	7910043700	
Cooled Double-pass Glass Cyclonic Action Spray Chamber with Cooling Gallery (requires, but does not include, a refrigerated water cooler for sub-ambient operation. Includes mounting bracket for Liberty Series I/II, Vista and 700-ES series instruments. Ideal for use with highly volatile organic solvents)	9910070400	
Sturman-Masters Spray Chamber (white) (for samples dissolved in hydrofluoric acid (HF) or when using the V-groove nebulizer for fusions or slurries)	110593190	
Bracket for Mounting Glass Cyclonic Spray Chambers (for Varian 715/725/735-ES radial, Vista-PRO radial and early axial, Vista-MPX radial and Liberty Series II radial and early axial models)	110611700	

Ordering Information

ICP-OES spray chambers and brackets continued

Description	Part No.	
Bracket for Mounting Glass Cyclonic Spray Chambers (for Varian 710/720/730-ES axial, Vista-PRO axial, Vista-MPX axial and Liberty Series II axial models)	110665200	
Bracket for Mounting Sturman-Masters Spray Chamber (for Varian 715/725/735-ES radial, Vista-PRO radial and early axial, Vista-MPX radial models and Liberty Series II radial and early axial models)	410298400	
Bracket for Mounting Sturman-Masters Spray Chamber (for Varian 710/720/730-ES axial, Vista-PRO axial, Vista-MPX axial and Liberty Series II axial models)	410328600	

Spray Chamber and Nebulizer Kits: Maximize Up-time

Ordering Information

Description	Part No.
Sample Compartment O-ring Kit, with all O-rings for the Spray Chamber Area, Demountable Torch and ASA	9910057200
Sample Compartment/Torch Box Tube Connection Kit (includes all tubing for spray chamber area and spare nipples for drain (excluding pump tubing))	9910057100









ICP-OES

Nebulizers and Accessories: Worry-free Fittings From Varian

- Manufactured to fine tolerances for reproducible and stable sample uptake
- Tight specifications deliver fine droplets for best signal intensity and optimum signal to noise
- Fewer repeats means less downtime and improved productivity

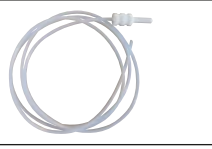
Ordering Information

Description	Application	Part No.	
Concentric Glass Nebulizer (Seaspray) with Sample and Gas Inlet Fittings	Routine analysis of samples to 20% total dissolved solids (TDS)	2010096400	
K-style (Conikal) Concentric Glass Nebulizer with Sample and Gas Inlet Fittings	Routine analysis of samples to 5% TDS	2010106800	
Micro-concentric Glass Nebulizer (Micromist) (0.4 mL/min uptake) and Sample and Gas Inlet Fittings	Small sample volumes	2010102100	
Inert V-groove Nebulizer Kit with tubing and fittings for use with the Sturman-Masters Spray Chamber	Samples with hydrofluoric acid, fusions, slurries or >20% TDS	9910057400	
Concentric Glass Slurry Nebulizer	Slurry samples with particles to 150 µm, or >20% TDS	2010097600	
High Flow Concentric Glass Slurry Nebulizer for Liberty Series II Axial Systems	Slurry samples or those >20% TDS	2010097700	
High Flow K-style (Conikal) Concentric Glass Nebulizer with Fittings for Sample and Gas Inlets for Liberty Series II Axial Systems	Routine analysis of samples to 5% TDS	2010081600	
Sample Inlet (EzyFit) Fitting for Concentric Glass Nebulizer on Axial ICP-OES 0.75 mm ID x 1.3 mm OD Capillary Tubing. 10/pack.		9910107700	
Sample Inlet (EzyFit) Fitting for Concentric Glass Nebulizer on Radial ICP-OES 0.75 mm ID x 1.6 mm OD Capillary Tubing. 10/pack. (Suitable for SVS1 accessory)		1610136400	
Gas Inlet Connector (EzyLok) for Concentric Glass Nebulizer		9910127800	
Y Piece Connector for Online Addition of Internal Standard/Ionization Buffer		1610132400	
Nebulizer Bung O-ring Kit, 7/32 in. ID, 11/32 in. OD		6910008200	
Nalgene™ 1/8 in. ID x 1/4 in. OD Tubing, per m. (connects argon supply to nebulizer)		3710031500	

SUPPLIES





ICP-OES

ICP-OES Torches: Optimized to Prolong Instrument Stability



- Torches light easily and stay lit, reducing downtime
- Even and stable plasma delivers reproducible results
- Varian torches guard your instrument warranty to protect your investment

Ordering Information

One piece axial ICP-OES torches, for all Varian axial ICP-OES

Description	Application	Part No.	
Low Flow Quartz Torch with 2.4 mm ID Injector Tube	Routine analysis of aqueous samples <10% TDS	2010090400	
Low Flow Quartz Torch with 0.8 mm ID Injector Tube	Routine analysis of volatile organic solvents, e.g. gasoline	2010104700	
Low Flow Quartz Torch with 1.4 mm ID Injector Tube	Routine analysis of organic solvents, e.g. kerosene, xylene and white spirit	2010104800	
High Solids Torch with Patented Injector Design (2.4 mm ID)	Routine analysis of samples to 25% TDS	2010094800	
Extended High Solids Torch Standard Length Axial Torch with Patented Injector Design (2.4 mm ID)	Routine analysis of samples to 25% TDS	2010104600	
Sheath Gas High Solids Torch with Patented Injector Design (2.4 mm ID) (used with the AGM-1 oxygen addition accessory (10055900) for better performance than the extended high solids torch)	Routine analysis of samples to 25% TDS	2010122400	

One piece radial ICP-OES torches, for all Varian radial ICP-OES

Description	Application	Part No.	
Low Flow Quartz Torch with 1.4 mm ID Injector Tube	Routine analysis of aqueous samples <10% TDS	2010069690	
Low Flow Quartz Torch with 0.8 mm ID Injector Tube, Annealed for Greater Strength	Routine analysis of volatile organic solvents, e.g. gasoline	2010117400	
Low Flow Quartz Torch with 1.4 mm ID Injector Tube, Annealed for Greater Strength	Routine analysis of organic solvents, e.g. kerosene, xylene and white spirit	2010117500	
High Solids Torch with Patented Injector Design (1.8 mm ID)	Routine analysis of samples to 25% TDS	2010095000	



ICP-OES

Ordering Information



ICP-OES torch spares

Description	Part No.	
Spare Quartz Torch Bonnet for Radial ICP-OES	2010070790	
Torch Alignment Tool for Radial ICP-OES	7210020700	
GazFit Fittings for One Piece and Semi-demountable ICP-OES Torches (4/pack)	9910107100	
Transfer Tube FEP Cyclone Spray Chamber for Radial ICP	7910051290	
Transfer Tube FEP Sturman-Masters Spray Chamber for Radial ICP	7910051490	
Transfer Tube FEP for Axial ICP	7910051590	
Silicon Tubing 3/16 in. ID x 5/16 in. OD, per m (connects the torch plasma and auxiliary lines to the argon supply)	2410023800	

Cones for axial ICP-OES





Description	Part No.
Finger Nut for Cone	1510220200
Pre-optics Cone for Vista/700-ES Series Axial ICP-OES	3610007300
Pre-optics Cone for Liberty Series Axial ICP-OES	3610006200
Esteele Cleaning Powder (for cleaning the interface cone on the axially-viewed ICP-OES)	8110002800

Semi-demountable ICP-OES torches, fitted with low flow torch body, 1.8 mm ID alumina injector tube and holder

Description	Application	Part No.	
Semi-demountable Inert Axial Torch Assembly Kit	Samples with free HF when used with an inert alumina injector (2410067590) (for volatile organic solvents use the narrow bore 0.8 mm ID quartz injector (2010077500))	9910084700	
Semi-demountable Inert Radial Torch Assembly Kit	Samples with free HF when used with an inert alumina injector (2410067590) (for volatile organic solvents use the narrow bore 0.8 mm ID quartz injector (2010077500))	9910056800	

Ordering Information

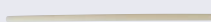
Spares for semi-demountable torches

Description	Part No.	
Spare Semi-demountable Quartz Torch Body, for Axial ICP-OES	2010083400	
Spare Semi-demountable Quartz Torch Body, for Radial ICP-OES	2010072900	
Injector Holder Kit for Semi-demountable Torch (includes O-rings)	9910057300	
Alumina Injector Tube (1.8 mm) for Semi-demountable Torch	2410067590	
Quartz Injector Tube Kit (1.4 mm) for Semi-demountable Torch (3/pack)	9910057000	
Quartz Injector Tube (0.8 mm) for Semi-demountable Torch	2010077500	



ICP-OES

Peristaltic Pump Tubing: Cost Effectiveness with Aqueous Samples

- PVC Solva (solvent flex) for common organic solvents such as kerosene, xylene and white spirit
- Marprene™ tubing for ketone-based solvents such as MIBK and DIBK
- Viton® tubing for longer operating life with strong acids and most organics

Ordering Information

PVC tubing for aqueous samples

Description	Part No.
Peristaltic Pump Tubing (orange/white)	3710046900
Peristaltic Pump Tubing (black/black)	3710027200
Peristaltic Pump Tubing (white/white)	3710034400
Peristaltic Pump Tubing (gray/gray)	3710034500
Peristaltic Pump Tubing (blue/blue)	3710034600

Replacement tubing for ICP-OES, aqueous samples

Description	Part No.
Tubing Spray chamber to Torch, per m	3710033400
Spray Chamber to Peri Pump Waste Line (Sturman-Masters spray chamber), per m	3710033900
Spray Chamber to Peri Pump Waste Line (glass cyclonic spray chamber), per m	3710024600
Nebulizer Capillary Tubing, per m	2410020500

PVC Solva (solvent flex) tubing, low volatile organic samples

Description	Part No.
Peristaltic Pump Tubing (black/black)	3710034800
Peristaltic Pump Tubing (white/white)	3710035000
Peristaltic Pump Tubing (gray/gray)	3710035200
Peristaltic Pump Tubing (purple/black)	3710047000

Replacement tubing for ICP-OES, low volatile organic samples

Description	Part No.
Tubing Spray chamber to torch, per m	3710037800
Spray Chamber to Peri Pump Waste Line (Sturman-Masters spray chamber), per m	3710035300
Spray Chamber to Peri Pump Waste Line (glass cyclonic spray chamber), per m	3710035400
Nebulizer Capillary Tubing, per m	2410020500

Ordering Information

Marprene tubing, ketone based organic samples

Description	Part No.
Peristaltic Pump Tubing (orange/yellow)	3710044000
Peristaltic Pump Tubing (black/black)	3710044100
Peristaltic Pump Tubing (white/white)	3710044200
Peristaltic Pump Tubing (gray/gray)	3710044300
Peristaltic Pump Tubing (blue/blue)	3710044400

Replacement tubing for ICP-OES, ketone based organic samples

Description	Part No.
Tubing Spray Chamber to Torch, per m	3710037800
Spray Chamber to Peri Pump Waste Line (Sturman-Masters spray chamber), per m	3710035300
Spray Chamber to Peri Pump Waste Line (glass cyclonic spray chamber), per m	3710035400
Nebulizer Capillary Tubing, per m	2410020500

Viton tubing, aromatic organic samples

Description	Part No.
Peristaltic Pump Tubing (orange/yellow)	3710043500
Peristaltic Pump Tubing (black/black)	3710043600
Peristaltic Pump Tubing (white/white)	3710043700
Peristaltic Pump Tubing (gray/gray)	3710043800
Peristaltic Pump Tubing (blue/blue)	3710043900

Internal Standard Kit (includes standard PVC pump tubing, one pack of EzyFit connectors, five Y pieces and connecting tubing)

Description	Part No.
Internal Standard Kit 1 (with black/black pump tubing)	9910124000
Internal Standard Kit 2 (with orange/white pump tubing)	9910124100



ICP-OES

Ordering Information

ICP-OES tubing kits

Aqueous samples and high dissolved solids kit (includes standard PVC pump tubing (one each blue/blue and white/white), FEP transfer tube (spray chamber to torch), drain tubing, tubing for waste line, one pack of EzyFit connectors, nebulizer capillary tubing, connectors and connecting tubing)

Description	Use with	Part No.
Aqueous Tubing Kit 1 - Axial	Seaspray/K-Style Nebulizers and Double or Single Pass Cyclonic Spray Chamber	9910123600
Aqueous Tubing Kit 1 - Radial	Seaspray/K-Style Nebulizers and Double or Single Pass Cyclonic Spray Chamber	9910123700
Aqueous Tubing Kit 2 - Axial	V-Groove Nebulizer and Sturman-Masters Spray Chamber	9910123800
Aqueous Tubing Kit 2 - Radial	V-Groove Nebulizer and Sturman-Masters Spray Chamber	9910123900

Organic samples (for low volatile organic solvents) (includes PVC Solva pump tubing (one each black/black and white/white), FEP transfer tube (spray chamber to torch), drain tubing, tubing for waste line, one pack of EzyFit connectors, nebulizer capillary tubing, connectors and connecting tubing)

Description	Use with	Part No.
Organics Tubing Kit 1 - Axial	Seaspray Nebulizer and Double Pass Cyclonic Spray Chamber	9910124200
Organics Tubing Kit 1 - Radial	Seaspray Nebulizer and Double Pass Cyclonic Spray Chamber	9910124300
Organics Tubing Kit 2 - Axial	V-Groove Nebulizer and Sturman-Masters Spray Chamber	9910124400
Organics Tubing Kit 2 - Radial	V-Groove Nebulizer and Sturman-Masters Spray Chamber	9910124500

Organic samples, aromatic organic solvents (includes Viton® pump tubing (one each black/black and white/white), FEP transfer tube (spray chamber to torch), drain tubing, tubing for waste line, one pack of EzyFit connectors, nebulizer capillary tubing, connectors and connecting tubing)

Description	Use with	Part No.
Organics Tubing Kit 3 - Axial	Seaspray Nebulizer and Double Pass Cyclonic Spray Chamber	9910124600
Organics Tubing Kit 3 - Radial	Seaspray Nebulizer and Double Pass Cyclonic Spray Chamber	9910124700
Organics Tubing Kit 4 - Axial	V-Groove Nebulizer and Sturman-Masters Spray Chamber	9910124800
Organics Tubing Kit 4 - Radial	V-Groove Nebulizer and Sturman-Masters Spray Chamber	9910124900

Ordering Information

Organic samples, ketone based organic solvents (includes Marprene™ pump tubing (one each black/black and white/white), FEP transfer tube (spray chamber to torch), drain tubing, tubing for waste line, one pack of EzyFit connectors, nebulizer capillary tubing, connectors and connecting tubing)

Description	Use with	Part No.
Organics Tubing Kit 5 - Axial	Seaspray Nebulizer and Double Pass Cyclonic Spray Chamber	9910125000
Organics Tubing Kit 5 - Radial	Seaspray Nebulizer and Double Pass Cyclonic Spray Chamber	9910125100
Organics Tubing Kit 6 - Axial	V-Groove Nebulizer and Sturman-Masters Spray Chamber	9910125200
Organics Tubing Kit 6 - Radial	V-Groove Nebulizer and Sturman-Masters Spray Chamber	9910125300

Volatile organic samples (includes Viton pump tubing (one each black/black and white/white), FEP transfer tube (spray chamber to torch), drain tubing, tubing for waste line, one pack of EzyFit connectors, nebulizer capillary tubing, connectors and connecting tubing)

Description	Use with	Part No.
Volatile Organics Tubing Kit - Axial	Seaspray Nebulizer, Cooled Spray Chamber and Full Length Torch	9910125400
Volatile Organics Tubing Kit - Radial	Seaspray Nebulizer, Cooled Spray Chamber and Annealed (organics) Torch or Semi-Demountable Torch	9910125500



ICP-OES

Applications Kits: Specially Designed for Your Application

Ordering Information

High dissolved solids kit (contains nebulizer, spray chamber, mounting bracket, patented high-solids torch (unless otherwise stated), argon saturator accessory and all necessary tubing)

Description	Nebulizer, Spray Chamber	Part No.
High Solids Kit 1 - Axial	Seaspray Nebulizer, Double-pass Glass Cyclonic Spray Chamber	9910125600
High Solids Kit 1 - Radial	Seaspray Nebulizer, Double-pass Glass Cyclonic Spray Chamber	9910125700
High Solids Kit 2 - Axial	V-groove Nebulizer, Sturman-Masters Spray Chamber	9910125800
High Solids Kit 2 - Radial	V-groove Nebulizer, Sturman-Masters Spray Chamber	9910125900
High Solids Kit 3 - Axial	V-groove Nebulizer, Sturman-Masters Spray Chamber (includes sheath gas high-solids torch with patented injector design (2.4 mm ID) and AGM-1 auxiliary gas module for flow control over sheath gas flow; for all axial ICP-OES; this kit allows determination of samples with >25% TDS)	9910141000

Inert sample introduction system kits. Contain V-groove nebulizer, double-pass, Sturman-Masters spray chamber with mounting bracket (unless otherwise stated), semi-demountable torch with 1.8 mm ID alumina injector and all necessary tubing. For solutions with free HF

Description	Part No.
Inert Kit - Axial	9910126000
Inert Kit - Radial	9910126100
Inert Kit - Radial (with semi-demountable torch, 1.8 mm ID alumina injector and all tubing; excludes spray chamber and mounting bracket)	9910126200

Kits for use with common organic solvents. Contains nebulizer, spray chamber with mounting bracket, one-piece torch with 1.4 mm ID injector and all necessary Marprene™ and solvent flexible PVC tubing. AGM-1 oxygen accessory is recommended (10055900) when analyzing organic solvents on axial ICP-OES

Description	Applications	Nebulizer, Spray Chamber	Part No.
Organics Kit 1 - Axial	Common, low volatility organic solvents, e.g. kerosene, xylene and white spirit	Glass Concentric (Conikal) Nebulizer, Double-pass, Glass Cyclonic Spray Chamber	9910126300
Organics Kit 1 - Radial	Common, low volatility organic solvents, e.g. kerosene, xylene and white spirit	Glass Concentric (Conikal) Nebulizer, Double-pass, Glass Cyclonic Spray Chamber, Annealed Torch	9910126400
Organics Kit 2 - Axial	High particulate samples dissolved in common, low volatility organic solvents, e.g. kerosene, xylene and white spirit	V-groove Nebulizer, Double-pass, Sturman-Masters Spray Chamber	9910126500
Organics Kit 2 - Radial	High particulate samples dissolved in common, low volatility organic solvents, e.g. kerosene, xylene and white spirit	V-groove Nebulizer, Double-pass, Sturman-Masters Spray Chamber, Annealed Torch	9910126600

Ordering Information

Kits for use with ketone based organic solvents. Contains nebulizer, spray chamber with mounting bracket, one-piece torch with 1.4 mm ID injector and all necessary solvent flexible PVC tubing. AGM-1 oxygen accessory is recommended (10055900) when analyzing organic solvents on axial ICP-OES

Description	Nebulizer, Spray Chamber	Part No.
Organics Kit 5 - Axial	Glass Concentric (Conikal) Nebulizer, Double-pass, Glass Cyclonic Spray Chamber	9910127100
Organics Kit 5 - Radial	Glass Concentric (Conikal) Nebulizer, Double-pass, Glass Cyclonic Spray Chamber, Annealed Torch	9910127200
Organics Kit 6 - Axial	V-groove Nebulizer, Double-pass, Sturman-Masters Spray Chamber	9910127300
Organics Kit 6 - Radial	V-groove Nebulizer, Double-pass, Sturman-Masters Spray Chamber, Annealed Torch	9910127400

Volatile Organics Kit reduces vapor pressures that can destabilize the plasma and lead to signal loss. Contains glass concentric (Conikal) nebulizer, water-cooled spray chamber with mounting bracket, one-piece torch with 0.8 mm ID injector and all necessary Viton and solvent flexible PVC tubing. AGM-1 oxygen accessory is recommended (10055900) when analyzing volatile organic solvents. Cooled spray chamber requires a refrigerated, recirculating water-cooler able to cool fluid down to -10 °C. For analysis of volatile organic solvents such as gasoline and naphtha

Description	Part No.
Volatile Organics Kit - Axial	9910127500
Volatile Organics Kit - Radial, with Annealed Torch	9910127600



ICP-MS

Inert Sample Introduction Kit for Varian 810/820-MS

- O-ring free kit ideal for samples containing HF and other strong acids, or when pushing for the lowest detection limits
- PFA is generally cleaner (lower contamination and lower backgrounds) and easier to clean than glass or quartz for less downtime
- An inert sample introduction kit is a must for geochemical and semiconductor ICP-MS users to maximize productivity

The kit contains:

Platinum or Sapphire Injector
 PFA Injector Support (Torch Bung)
 Semi-demountable Torch
 PFA 100 µL/min Nebulizer
 PFA Spray Chamber
 PFA Spray Chamber End Cap
 PFA Sheath Gas Accessory Line
 Adapter Kit for Drain and Sheath Gas

Ordering Information

Inert kit and additional spares

Description	Part No.
Inert Sample Introduction Kit with Platinum Injector	9910116400
Inert Sample Introduction Kit with Sapphire Injector	9910136200
Platinum Injector - 2 mm ID with PFA Support	3610011400
Sapphire Injector - 1.8 mm ID with PFA Support	3610012100
PFA Nebulizer, 100 µL/min	2010104500
Semi-demountable Torch	2010104200
Scott Spray Chamber PFA	2010104400
PFA Spray Chamber End Cap	810186000
Accessory PFA Sheath Gas	2010104300
Adapter Kit for Drain and Sheath Gas	9910117300



ICP-MS Cones

Nickel cones are suitable for the majority of applications, and platinum-tipped cones are recommended for the analysis of highly acidic and corrosive samples.



Ordering Information

Varian 810-MS and 820-MS

Description	Part No.
Nickel Sampler Cone Kit for the 800-MS series (non-CRI)	9910115300
Nickel Skimmer Cone Kit for the 800-MS series (non-CRI)	9910121000
Platinum-tipped Sampler Cone Kit for the 800-MS series (non-CRI)	9910117000
Platinum-tipped Skimmer Cone Kit for the 800-MS series (non-CRI)	9910121100
Standard Nickel Sampler Interface Cone Kit for the 820-MS (recommended for applications that require interference management via the CRI skimmer cone only)	9910135900
Nickel Sampler Cone Kit for the CRI 820-MS	9910121400
Nickel Skimmer Cone Kit for the CRI 820-MS	9910121200
Standard Platinum-tipped Sampler Cone Kit for the 820-MS (recommended for applications involving highly acidic and corrosive samples that require interference management via the CRI skimmer cone only)	9910136000
Platinum-tipped Sampler Cone Kit for the CRI 820-MS	9910121500
Platinum-tipped Skimmer Cone Kit for the CRI 820-MS	9910121300

Varian ICP-MS (with red top-cover)

Description	Part No.
Nickel Sampler Cone Kit	9910115300
Nickel Skimmer Cone Kit	9910115400
Platinum-tipped Sampler Cone Kit	9910117000
Platinum-tipped Skimmer Cone Kit	9910117100

UltraMass

Description	Part No.
Nickel Sampler Cone Kit	9910094000
Nickel Skimmer Cone Kit	9910094100
Platinum-tipped Sampler Cone Kit	9910070000
Platinum-tipped Skimmer Cone Kit	9910070100



ICP-MS

Productivity Package

This software controlled, 4-port switching valve system substantially increases productivity through more efficient introduction and removal of sample from the system. Instrument exposure to high matrix sample types is also reduced, providing greater analysis stability and accuracy.

Peristaltic Tubing

Standard PVC is suitable for most aqueous sample types, and solvent flexible PVC for general purpose organic solvents such as kerosene, Shellsol™ and white spirit. We also supply solvent specific tubing, for example ketone compatible Marprene™ and Viton®, which are suited to strongly acidic/basic sample matrices and show greater tolerance to aromatic hydrocarbon solvents such as xylene and toluene.

Ordering Information

Description	Part No.	
Productivity Package for Varian 800-MS Series	9910121900	
Spare 4-port Valve	3610010100	
SVS Ezyfit Connector (0.75 mm ID x 1.6 mm OD) (10/pk)	1610136400	
FEP Capillary Tubing (0.0625 in. OD x 0.02 in. ID)	3710052400	
Flangeless Fitting (4/pk)	1610136500	
Ferrule (4/pk)	1610136600	

Ordering Information

Tubing (12/pk unless otherwise stated)

Use With	Description	Part No.
Aqueous Solutions	PVC, Orange/White (0.02 in. ID)	3710046900
	PVC, Black/Black (0.03 in. ID)	3710027200
	PVC, White/White (0.04 in. ID)	3710034400
	PVC, Gray/Gray (0.051 in. ID)	3710034500
	PVC, Blue/Blue (0.065 in. ID)	3710034600
Common Organic Solvents	Solvent Flexible PVC, Black/Black (0.03 in. ID)	3710034800
	Solvent Flexible PVC, White/White (0.04 in. ID)	3710035000
	Solvent Flexible PVC, Gray/Gray (0.051 in. ID)	3710035200
Strong Acids/Bases and Alternate Organic Solvents	Viton Orange/Yellow (0.02 in. ID) (6/pk)	3710053500
	Viton Black/Black (0.03 in. ID) (6/pk)	3710053600
	Viton White/White (0.04 in. ID) (6/pk)	3710053700
	Viton Gray/Gray (0.05 in. ID) (6/pk)	3710053800
	Viton Blue/Blue (0.065 in. ID) (6/pk)	3710053900
	Viton Orange/Yellow (0.02 in. ID)	3710043500
	Viton Black/Black (0.03 in. ID)	3710043600
	Viton White/White (0.04 in. ID)	3710043700
	Viton Gray/Gray (0.05 in. ID)	3710043800
	Viton Blue/Blue (0.065 in. ID)	3710043900
Ketone-based Solvents	Marprene, Orange/Yellow (0.02 in. ID)	3710044000
	Marprene, Black/Black (0.03 in. ID)	3710044100
	Marprene, White/White (0.04 in. ID)	3710044200
	Marprene, Gray/Gray (0.05 in. ID)	3710044300
	Marprene, Blue/Blue (0.065 in. ID)	3710044400



ICP-MS

Ordering Information

Drain/waste tubing (1 m/pk)

Type	Use With	Description	Part No.
Drain Line	Aqueous Solutions (PVC)	Scott Spray Chamber Drain Tubing (1/4 in. ID)	37100334000
	Aqueous Solutions (PVC)	Sturman-Masters Spray Chamber Drain Tubing (1/16 in. ID)	3710033900
	Organic Solvents (Solvent-flexible PVC)	Scott Spray Chamber Drain Tubing (1/4 in. ID)	3710037800
	Organic Solvents (Solvent-flexible PVC)	Sturman-Masters Spray Chamber Drain Tubing (1/16 in. ID)	3710035300
	Ketone Solvents (Marprene™)	Sturman-Masters Spray Chamber Drain Tubing (1/16 in. ID)	3710035700
Waste Line	Aqueous Solutions	PVC Tubing (1/8 in. ID x 1/4 in. OD)	3710024600
	Organic Solvents	Solvent-flexible PVC Tubing (1/8 in. ID x 1/4 in. OD)	3710035400
	Ketone Solvents	Marprene Tubing (1/16 in. ID)	3710035700

Tubing spares (1 m/pk, unless otherwise stated)

Description	Part No.
Capillary Tubing, Polyethylene (0.63 mm ID x 1.5 mm OD)	2410020500
Y Connector for Online Addition of Internal Standard Solution	1610132400
EzyFit Connector for Glass Concentric Nebulizer (0.75 mm ID x 1.3 mm OD) (10/pk)	9910107700
UltraMass Startup Tubing Kit	9910018700

Tip

For narrow bore ID tubing such a black/black or orange/yellow, heat in warm water to make connecting with capillary tubing easier.

Ordering Information

Gas line tubing (1 m/pk)

Type	Description	Part No.
Plasma and Auxiliary Gas Tubing	Silicon Tubing (3/16 in. ID x 5/16 in. OD)	2410023800
Plasma and Auxiliary Gas Tubing Adapters	Torch Fittings "Gaz-Fit" for Plasma and Auxiliary Gas Tubing, 6 mm ID (4/pk)	9910107100
Sheath Gas Tubing	Silicon Tubing (1/4 in. ID x 5/16 in. OD)	3710038300
Nebulizer Gas Tubing	High Pressure PVC Tubing (1/8 in. ID x 1/4 in. OD)	3710031500

Nebulizers

Ordering Information

For use with Varian ICP-MS and 800-MS Series

Description	Part No.
Micromist Low Flow Nebulizer – 0.4 mL/min uptake (0.7 L/min Ar at 30 psi)	2010102100



For use with UltraMass

Description	Part No.
Concentric High Flow Nebulizer, K-Style (1.0 L/min Ar at 30 psi)	2010081600



Spray Chambers

Ordering Information

For use with Varian ICP-MS and 800-MS Series

Description	Part No.
Scott Style Spray Chamber	2010101000



For use with UltraMass

Description	Part No.
Sturman-Masters Spray Chamber	110593190





ICP-MS

Torches

Ordering Information

For use with Varian ICP-MS and 800-MS Series

Description	Part No.
Standard One Piece, Low Flow Quartz Torch (2.4 mm ID injector), for aqueous solutions	2010100700
One Piece, Low Flow Quartz Torch (1.5 mm ID injector), for organic solvents	2010123600
One Piece, Low Flow Quartz Torch (0.8 mm ID injector), for volatile organic solvents	2010123500
Glass ICP-MS Sheath Gas Port	2010100900



For use with UltraMass

Description	Part No.
One Piece, Low Flow Quartz Torch	2010078300

Detectors

Ordering Information

Use with	Description	Part No.
Varian ICP-MS and 800-MS Series	Detector, Discrete Dynode Electron Multiplier	7910046800
UltraMass	Detector, Discrete Dynode Electron Multiplier	7910018100

Ion Optics

Ordering Information

For use with UltraMass

Description	Part No.
Extraction Lens (5/pk)	110468290
Complete Ion Lens Assembly (spare)	110466090



Plasma Coils

Ordering Information

(Per set)

Description	Part No.
Turner Interlaced Work Coils for Varian ICP-MS and 800-MS Series	110749090
Turner Interlaced Work Coils for UltraMass	110467490



Chemicals

Ordering Information

Description	Part No.
Varian ICP-MS Tuning Solution (250 mL, contains Be, Mg, Co, In, Pb, Th, Ba, Ce (10 mg/L))	190024400

Sample Introduction Tray

Ordering Information

Description	Part No.
ICP-MS Tray with Overflow Port (Varian ICP-MS and 800-MS Series)	110840100
Overflow Port Waste Tubing (PVC tubing, 1/8 in. ID x 1/4 in. OD, 1 m)	3710009200

Cleaning Supplies

Ordering Information



Description	Part No.
Lint-free Nylon Gloves	7210024800
Cone Cleaning Powder, Esteel (500 g)	8110002800

ICP-MS

Interface Spares

Ordering Information

Varian ICP-MS and 800-MS Series

Description	Part No.	
Skimmer Cone Tool	110758700	
Sampler Cone Tool	110746800	

O-rings and Gaskets

Ordering Information

Use With	Description	Part No.
Varian 800-MS Series	Sampler Cone O-ring Kit for 810/820-MS (Includes five sampler cone O-rings, and five CRI sampler O-rings)	9910129200
	Skimmer Cone O-ring Kit for 810/820-MS (includes ten skimmer cone O-rings)	9910129300
Varian ICP-MS	Copper Gasket, Skimmer Cone Kit (10/pk)	6910043590
Varian ICP-MS and 800-MS Series	Sampler Cone O-ring (silicon)	6910042000

Vacuum Pump

Ordering Information

Use With	Description	Part No.
Varian ICP-MS and 800-MS Series	Oil Permavis 10, 3.78 L	8110003000
	Oil Drain Kit - Upgrade	9910140900
UltraMass	Oil, Chemically Resistant (Fomblin™), 1 L	8210037400



UV-Vis-NIR

UV-Vis-NIR Cuvettes and Flow Cells: Wide Variety of High Quality Cells for UV-Vis-NIR Spectrometers

Cell Shapes

Cylindrical Cells: For use when sample volume is not a limitation and when very short to long path lengths are needed. All cylindrical cells can be used with the cylindrical cell holder or the thermostatted cylindrical cell holder. Cylindrical cells are available as standard cells, long path length cells for extra sensitivity when measuring low concentrations, and microcells, suitable for concentrated samples, or to overcome solvent absorbance e.g. water in the NIR or the low UV.

Rectangular Cells: Rectangular cells are the most commonly used cell type and vary in shape from square to longer rectangles, depending on the cell path length. We offer standard cells, semimicro cells with about 40% of the volume of a standard cell of the same path length, microcells with about 20% of the volume of a standard cell, submicro and ultramicro cells that have microliter volumes, and disposable cells. Semimicro cells can be used with all current Varian instruments and Varian Cary™ 1, 3, 4, 5 multicell holders, and with all standard single cell holders. In addition, they can be used with the Varian Temperature Probe accessory for cell temperature monitoring.

Disposable polystyrene cells are useable from 340 to 800 nm, are economical, can be used with magnetic stirrers, but cannot be used at elevated temperatures. Cells sold as matched pairs are used for most UV-Vis-NIR routine analyses. Matched pairs ensure these cells will give a similar absorbance or transmission reading when empty or filled with water. Long path length cells are ideal for use when extra sensitivity is needed for low concentration samples. These cells must be used with the long path length rectangular cell holder.

Cell Materials

Cells are available in four materials. Select the cell material depending on the wavelength range of your measurements.

Material	Wavelength (nm)
Far UV Quartz	170 to 2700
Infrasil™ NIR Quartz	220 to 3800
Glass	334 to 2500
Polystyrene (disposable)	340 to 800

Cell Volumes

Standard Cells: Standard cells have about the same wall thickness on all sides, and are used for most UV-Vis-NIR measurements. They require the largest sample size for a given path length.

Semimicro Cells: Semimicro cells have thicker side walls to reduce the volume to about 40% of the volume of a standard cell of the same path length. These cells are useful when only small sample volumes are available for testing. Cells that are black self-masking are listed with their aperture size. The aperture is located at the correct Z-height for Varian UV-Vis spectrometers. Semimicro cells can be used with all current Varian instruments and Varian Cary 1, 3, 4, 5 multicell holders, and with all standard single cell holders. They can also be used with the Varian Temperature Probe accessory for cell temperature monitoring. The semimicro cell, with a stirring well for a magnetic stirring bar, is suitable for all current Varian and Cary 1, 3, 4, 5 series Peltier thermostatted multicell and single cell holders.

Microcells: Microcells have thicker sidewalls to reduce the volume to about 20% of the volume of a standard cell of the same path length. These cells are useful when limited sample volumes are available for testing.

Submicro cells: Submicro cells have volumes in the 10 to 135 µL range, and are ideal when sample volumes are very limited, for highly concentrated samples, or for highly absorbing solvents. These quartz cells offer low volume, short path length and excellent heat transfer. They are ideal for temperature-controlled work, and all except the 1 mm path length cell can be used with the Varian Temperature Probe. Cells that are black self-masking are listed with their aperture size. The aperture is located at the correct Z-height for Varian UV-Vis spectrometers.

Ultramicro cells: These cells have very small volumes generally below 10 µL, for use when the sample volume is extremely limited, for highly concentrated samples, or for highly absorbing solvents. Also, Varian offers an innovative ultramicro cell for the Cary 50 with a lens to capture more incident light. This cell fits the Cary 50 microcell holder. These cells are not suitable for use with any of the multicell holders.



UV-Vis-NIR

Ordering Information

Cary™ 50 cells

Type of Cell	Description	Material	Volume (μL)	Path Length (mm)	Sample Chamber Width (mm)	Aperture (mm)	Part No.
Rectangular	Submicro Cell, Black Wall	Far UV Quartz	135	10	2.0	2.0	6610021100
	Submicro Cell, Black Wall (6/pk)	Far UV Quartz	135	10	2.0	2.0	6610021000
	Submicro Cell, Black Wall	Far UV Quartz	40	10	2.0	2.0	6610019500
	Ultramicro Cell with Lens, Black Wall	Far UV Quartz	5	5	0.8	0.8	6610019400

Cells with an aperture value are self-masking with a 20 mm Z dimension to match Cary spectrophotometers.

Disposable Cells

Ordering Information

Polystyrene, wavelength range 340 to 800 nm, 500/pk

Use With	Type	Description	Volume (mL)	Path Length (mm)	Sample Chamber Width (mm)	Part No.
All	Rectangular	Standard Cell	3.5	10	10	6610018800
	Rectangular	Microcell	1.5	10	4	6610018700

Magnetic stirrer bars

Description	Part No.
Magnetic Stirrer Bar, Teflon®, Star Type	7418000400
Magnetic Stirrer Bars, 7 x 2 mm (10/pk)	6610018900

Polarizer and Depolarizer

The polarizer is used to transmit only one polarized component of an incident light beam. Cary polarizers are mounted in a stainless steel slide (5 x 7.5 cm) with vernier and dial. A depolarizer is used to transmit the polarized component of an incident light beam with minimum degree of plane polarization, converting any plane polarization to a mixture of polarizations.

Ordering Information

Description	Use With	Part No.
Glan-Taylor Calcite Prism Polarizer	Cary 1, 3, 4, 5, 100, 300, 400 to 500i, 4000 to 6000i	210131600
Depolarizer, 1/4 Wave Scrambler		210131700
Glan-Thompson Calcite Prism Polarizer	Cary 1, 3, 4, 5, 100, 300, 400 to 500i, 4000 to 6000i	190029100



Cary Fiber Optic Probes

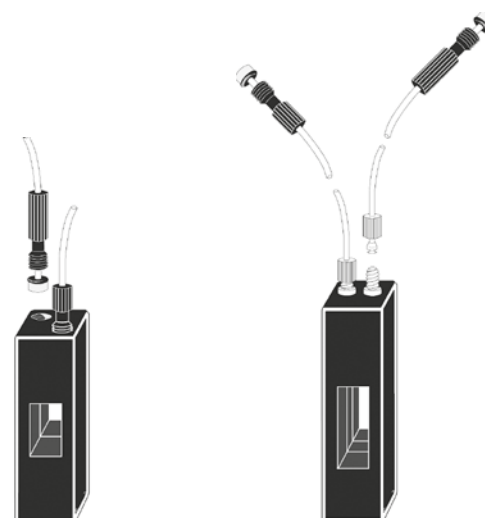

Cary 50 Flow Cell

Cary 100/300 Flow Cell

SUPPLIES



UV-Vis-NIR

Cells for all Cary™ Spectrophotometers

Cells with an aperture value are self-masking with a 20 mm Z dimension to match Cary spectrophotometers.

Ordering Information

Type of Cell: Cylindrical

Description	Material	Volume (mL)	Path Length (mm)	Sample Chamber Width (mm)	Part No.
Standard Cell, Two Ports, Matched Pair	Far UV Quartz	28.2	100	19	6610002300
	Far UV Quartz	14.1	50	19	6610002200
Standard Cell, One Port	Far UV Quartz	2.8	10	19	6618000600
Microcell	Far UV Quartz	2.3	1	15	6610014400
	Far UV Quartz	2.15	0.1	15	6610014500

Type of Cell: Rectangular

Description	Material	Volume (mL)	Path Length (mm)	Sample Chamber Width (mm)	Part No.
Standard Cell, Open Top	Glass	35.0	100	9.5	6610016300
	Far UV Quartz	35.0	100	9.5	6610016000
	Glass	17.5	50	9.5	6610016400
	Far UV Quartz	17.5	50	9.5	6610016100
Standard Cell, Open Top	Far UV Quartz	7.0	20	10.0	6610016200
	Glass	7.0	20	10.0	6610016500
Standard Cell, Disposable	Polystyrene (500/pk)	3.5	10	10.0	6610018800
Standard Cell, Open Top, Matched Pair	Infrasil™ NIR Quartz (1 pair)	3.5	10	10.0	6618000100
	Glass (1 pair)	3.5	10	10.0	6610008800
Standard Cell, Stoppered, Matched Pair	Far UV Quartz (1 pair)	3.0	10	10.0	6610001100
Standard Cell, Open Top, Matched Pair	Far UV Quartz	3.0	10	10.0	6610000800
Semimicro Cell, Black Wall	Far UV Quartz	1.4	10	4.0	6610001800
Standard Cell, Screw Top	Far UV Quartz	17.5	50	9.5	6610018400
Semimicro Cell	Far UV Quartz	1.4	10	4.0	6610009100
Semimicro Cell, For Magnetic Stirrer Bars, Black Wall	Far UV Quartz	1.3	10	4.0	6610015400
Semimicro Cell, Matched Pair, Black Wall	Far UV Quartz (1 pair)	0.9	10	4.0	6610012700
	Far UV Quartz (1 pair)	450 µL	5	4.0	6610019800
Semimicro Cell, Matched Pair, Black Wall	Far UV Quartz (1 pair)	180 µL	2	4.0	6610019700
	Far UV Quartz (1 pair)	90 µL	1	4.0	6610019600
Microcell, Black Wall	Far UV Quartz	400 µL	10	2.0	6610009000
Submicro Cell, Low Headspace Thermal Melt, Black Wall with 2.0 mm Aperture	Far UV Quartz	80 µL	10	2.0	6610024100
Submicro Cell, Low Headspace Thermal Melt, Black Wall	Far UV Quartz	40 µL	5	2.0	6610024000
Submicro Cell, Stoppered, Black Wall with 2.0 mm Aperture	Far UV Quartz	50 µL	10	2.5	6610010400
Submicro Cell	Far UV Quartz	10 µL	10	1.0	6610013800
Ultramicro Cell, Black Wall with 0.8 mm Aperture	Far UV Quartz	5 µL	10	0.8	6610013700
	Far UV Quartz	2.5 µL	5	0.8	6610013600
Ultramicro Cell, Low Headspace Thermal Melt, Black Wall	Far UV Quartz	8 µL	1	1.0	6610023900

Cells with an aperture value are self-masking with a 20 mm Z dimension to match Cary spectrophotometers



UV-Vis-NIR

Cary™ Flow Cells and Accessories: Cary UV-Vis-NIR Fiber Optic Probes

Flow cells allow the sample to pass through the cell and are connected to the sample source via tubing. We offer Micro and Submicro Flow Cells. Micro Flow Cells are suitable for use with all Cary accessories. Long path length flow cells are useful for low concentration samples and require the long path length rectangular cell holder. They can be used with a Varian Cary 1, 3, 100, 300 series Routine Sampler Accessory or a Varian Cary 50-series Sipper. Submicro flow cells are suitable for use with the Varian Cary 1, 3, 100, 300 series Routine Sampler Accessory (part number 10040500).

Ordering Information

Made from far UV quartz and for use with single cell or multicell holders

Use With	Volume (μL)	Path Length (mm)	Part No.
Cary 50	113	1	6610019900
	227	2	6610020000
	568	5	6610020100
	715	10	6610020200
Cary 1, 3, 100 and 300	113	1	6610014100
	227	2	6610014200
	568	5	6610014300
	715	10	6610015200
All	80	10	6610008900
	390	10	6610012600
	1 mL	50	6610010000
	2.1 mL	100	6610010100

Cary Cell Holders and Bases

Ordering Information

Use With	Description	Part No.
Cary 50	Cell Base	110648190
Cary 400 and 500	Cell Holder Base	10048100
Cary 4000 to 6000i	Cell Holder Base	110716190
All	Standard Cell Holder 10 mm. (Supplied as Standard with Cary 100/300 and Cary 5000/6000i)	110260190
All except Cary 50	Standard Cell Holder (10 mm) with z Height Adjustment from 0-20 mm. (Supplied as standard with Cary 4000)	110721900
Cary 50 only	Cary 50 Cell Holder, Spare	110645000

For configuration options and ordering information, visit www.varianinc.com, or contact your local Varian, Inc. office or distributor.

Cary UV-Vis-NIR Fiber Optic Probes

Ordering Information

Use With	Description	Part No.
Cary 50	FO Dip Probe, Stainless steel, Body Only. Requires stainless steel tip	7910035700
	FO Dip Probe, Stainless steel, Fixed 10 mm path tip	7910036400
	FO Dip Probe, Stainless steel, Replaceable 10 mm path tip	7910036500
	FO Dip Probe, Torlon, Body Only. Requires torlon tip	7910032600
	FO Dip Probe, Torlon, Fixed 10 mm path length	7910029900
	FO Dip Probe, Torlon, Replaceable 10 mm path tip	7910035100
	FO Dip Probe, Quartz, Fixed 10 mm path length	7910030300
Cary 100/300	FO Micro Probe, 3.5 mm diameter, Fixed 10 mm path length	7910035600
	FO Remote Read Probe, Stainless steel, Replaceable 10 mm path tip	7910030200
	Cary 100/300 Quartz Probe 10 mm path length	9910080800
	Cary 100/300 Quartz Probe Long Body	7910032100
	Cary 100/300 UV-Vis Reflectance Probe and Probe Holder	7910036200
	Cary 100/300 Stainless Steel Absorbance Dip Probe, 10 mm path, with Switch	9910085000
	Cary 100/300 Stainless Steel Absorbance Dip Probe, 10 mm path, with Switch and Coupler	9910085100
Cary 4000/5000/6000i	Cary 100/300 Transmission Probe and Holder	9910076700
	Cary 100/300 UV-Vis Reflectance Probe, Probe Holder not included	7910035500
	UV-Vis Reflectance Probe, 2 m	9910069300
	Stainless Steel UV-Vis Absorption Probe, 2.5 m, 10 mm path length	9910069400
	UV-Vis Transmission Probe and Holder, 2 x 3 m fibers	9910069600
Cary 5000/6000i	UV-Vis Et Vis-NIR Transmission Probes and Holder Kit, 4 x 3 m fibers	9910076500
	Vis-NIR Transmission Probe and Holder, 2 x 3 m fibers	9910076400
	Stainless Steel Vis-NIR Absorption Probe, 2.5 m, 10 mm path length	9910069500



UV-Vis-NIR

Fiber Optic Probe Accessories and Maintenance

Ordering Information

Use With	Description	Part No.
Cary™ 50	Cary 50 Dip Probe Coupler	210159300
	Cary 50 Fiber Optic Coupler	210159400
	Cary 50 Stainless Steel 2 mm path length, Replaceable Tip	7910036000
	Cary 50 Stainless Steel 5 mm path length, Replaceable Tip	7910035900
	Cary 50 Stainless Steel 10 mm path length, Replaceable Tip	7910035800
	Cary 50 Stainless Steel 40 mm path length, Replaceable Tip	7910036100
	Cary 50 Torlon 2 mm path length, Replaceable Tip	7910032800
	Cary 50 Torlon 5 mm path length, Replaceable Tip	7910032900
	Cary 50 Torlon 10 mm path length, Replaceable Tip	7910033000
	Cary 50 Torlon 20 mm path length, Replaceable Tip	7910034600
Cary 50 Torlon 40 mm path length, Replaceable Tip	7910034500	
Cary 100/300	Cary 100/300 Fiber Optic Coupler	10056200
	Cary 100/300 Stainless Steel 10 mm Replaceable Tip	9910076600
Cary 4000 to 6000i	UV-Vis-NIR Fiber Optic Coupler (FiberMate™ accy)	7910049200
All	Fiber Optic Alignment Loop	7910027200
	Fiber Optic Probe Light Shield	7910028900
	UV-Vis Reflectance Probe Holder, Spare	9910068500

UV-Vis-NIR Tubing

Ordering Information

Description	Part No.
Peristaltic Pump Tubing (tubing only, no connectors), per m	2410023800
Peristaltic Pump Tubing 1.0 mm ID Replacement Kit	3710045100
Peristaltic Pump Tubing 1.5 mm ID Replacement Kit	3710045000
Cary 50, Dissolution Tubing Spares Kit	6610020500
Cary 100/300, Dissolution Tubing Spares Kit	6610020600
Peristaltic Pump Tubing Replacement Kit	9910052900
Silicone Tubing, 1 mm ID, (for connecting nebulizer capillary to SPS Probe, per m)	3710026400
Spare Inlet/Outlet Tubing	3710044600

UV-Vis-NIR Lamps

Varian offers high quality lamps and detectors that produce top-level performance for your Cary spectrophotometer.

Ordering Information

Source lamps

Use With	Description	Part No.
All Cary UV-Vis except Cary 50	D ₂ UV Lamp	5610021800
Cary 50	Xenon Lamp Module	110639690
Cary 100 and 300	Visible Source Lamp	5610021700
Cary 400	UV Source Lamp less than 190 nm	5610135500
Cary 4000 to 6000i	D ₂ UV Lamp	110713990
	Visible QI Lamp	5610013900

UV-Vis-NIR detector

Description	Part No.
Photomultiplier Tube R928, 185-900 nm	5618000200
Photomultiplier Tube R955, 160-900 nm	5610024100
Cary 50 External Detector Mount	190036500

UV-Vis-NIR Reference Materials

Ordering Information

Optical filters

Description	Part No.
Attenuator Filter Kit with Neutral Density Screens and Blue Filter	9910047700
Holmium Oxide Filter	118020790
Holmium Oxide/Didymium Glass Filter Kit	10030200
Photometric Linearity Neutral Density Filter Kit	9910056100

Standards

Description	Part No.
Calibrated Color Standard, 2 in. OD, 4 per set	9910084300
Calibrated Solution Standards Kit	9910085200
Certified Diffuse Reflectance Wavelength and Wave Number Standard	9910081100
Certified Diffuse Reflectance Wavelength Standard	9910080900
Certified Reference Standard 1404 for USP Certification	190034200
Certified Reference Standard, Full Certification. Includes 190034200 and 9910085200	190034300
Specular Reflectance Standard 1 in. OD	190012800



Fluorescence

Cary™ Eclipse Fast Filter Accessory: For signal transduction studies

The Fast Filter Accessory for the Cary Eclipse is the ideal solution for investigating rapid intracellular ion movements into and out of cells (signal transduction) using ratiometric fluorescent probes. A pair of bandpass filters appropriate to the fluorophore under investigation must be mounted in the Fast Filter accessory. Varian offers filter pairs appropriate for measurement of the calcium binding dyes Fura-2 and Indo-1.

Ordering Information

Description	Part No.
Fura-2 Filters for Ca ²⁺ Measurements (340 and 380 nm bandpass filters, 20 nm SBW). Requires Fast Filter accessory.	7910043800
Indo-1 Filters for Ca ²⁺ Measurements (405 and 495 nm bandpass filters, 20 nm SBW). Requires Fast Filter accessory.	7910043900
Fast Filter Accessory for Cary Eclipse	10077400

Fluorescence Cell Holder and Base

Ordering Information

Use With	Description	Part No.
Cary Eclipse	Cell Holder, Fluorescence	0110664700
Cary Eclipse	Cell Holder Base, Fluorescence	0210167200

Fluorescence Cuvettes and Flow Cells: For small sample sizes

Ideal for use when you have only a small amount of sample, microcell cuvettes have the optimum Z height (the distance between the base of the cell and the center of the light beam) for the Cary Eclipse fluorescence spectrophotometer.

Ordering Information

Made from Far UV quartz

Cell Type	Description	Volume	Path Length (mm)	Part No.
Flow Cell	Flow Cell, 2 x 2 mm Emission Window, Includes 0.8 mm ID Tubing	40 µL	10	6610023700
	Flow Cell, 2 x 2 mm Emission Window, Includes 0.020 in. and 0.005 in. PEEK™ Tubing	40 µL	10	9910105100
	Flow Cell, Water Jacket	1.5 mL	10	6610013900
Rectangular	Fluorescence Cell, Open Top, Pair	3.5 mL	10	6610000900
	Fluorescence Cell, Stopped, Pair	3.5 mL	10	6610001200
	Fluorescence Cell, Anaerobic	3 mL	10	6610021400
	Fluorescence Cell, Two Sides Mirrored	3 mL	10	6610023500
	Submicro Cell, 4 x 10 mm window	400 µL	10	6610021500
	Submicro Cell, 2 x 2 mm window	40 µL	10	6610021600
Triangular	Submicro Cell, Low head space, Stopped	40 µL	10	6610024200
	Microcell, Stopped, Square base	1.7 mL		6610021200
	Microcell, Open Top, Square base	1.7 mL		6610021300
	Microcell, Stopped, Square Base and Top. (Recommended for use with Cary Eclipse)	1.7 mL		6610023400



Fluorescence

Fluorescence Microplates: For Higher Sensitivity

Our microplates are available in white for best overall well-to-well reproducibility, or black for the lowest background signal levels. Both types have high binding surfaces that bind medium and large biomolecules (greater than 10K D) that have hydrophobic and/or ionic groups. These microplates are recommended for the Cary™ Eclipse Microplate Reader Accessory.

Ordering Information

Format: 96-well

Surface Treatment	Sterile	Quantity (per pack)	Color	Part No.
High Binding	No	10	White	6610022400
		10	Black	6610022500
	100	White	6610022800	
		Black	6610022900	
Untreated	Yes	10	White	6610022300

Format: 384-well

Surface Treatment	Sterile	Quantity (per pack)	Color	Part No.
High Binding	No	10	White	6610022600
High Binding	No	10	Black	6610022700
High Binding	No	100	White	6610023000
High Binding	No	100	Black	6610023100

Fluorescence Fiber Optic Probes and Fiber Optic Couplers

Ordering Information

Description	Part No.
FO Dip Probe Coupler Accessory, Fluorescence	10076800
FO Coupler Accessory, Fluorescence	10076700
FO Dip Probe, Fluorescence	7910043100
FO Remote Read 2 m Probe, Fluorescence	7910043000

Fluorescence Lamps

The lamp module contains the long life Xenon flash lamp, Swartzchild collector focusing optics and electronics within a metal enclosure. This allows safe and easy replacement of the lamp.

Ordering Information

Description	Part No.
Xenon Flash Lamp Module for Cary Eclipse	110666090

Base Plate for Custom Accessories

This base plate incorporates locating holes and the Cary Eclipse rapid lockdown mechanism common to most Eclipse accessories. It can be used to mount custom accessories in the Eclipse sample compartment.

Ordering Information

Description	Part No.
Base Plate for Custom Accessories, Fluorescence	210167490

Fluorescence Reference Materials

Ordering Information

Description	Part No.
Water Filled Fluorescence Cuvette, Sealed	6610021800
Diffuser, Spare	110674800
Neutral Density Attenuator 1.5 Abs, Spare	110677500
Rhodamine B in Polymer Block	6610021900
Europium in Polymer Block	6610022200
Rhodamine B, Concentrated Solution Sealed in Triangular Cuvette	6610021700
Holmium Perchlorate 4% in Perchloric Acid, Sealed in a Quartz Cuvette. (Wavelength accuracy standard)	6610022100
Cell Holder for Holmium Perchlorate Cuvette. (Required for Cary Eclipse wavelength accuracy test using Holmium Perchlorate solution)	110678600
Fluorescence Samples, Set of Six Hydrocarbons in Polymer Blocks. (Four have broad fluorescence bands for 300-700 nm, and two have sharp emission bands for wavelength calibration and bandpass checking. Includes Rhodamine B in PMMA block (6610021900))	6610010300
Fluorescence Demonstration Kit. (Includes europium in PMMA, ovalene in PMMA, a sealed water cuvette, and a 10 x 10 mm fluorescence cuvette)	9910101900



Nuclear Magnetic Resonance

NMR Probes: Optimized for the Highest Possible Performance

- Consistent and superior performance solutions
- Wide choice to meet every application
- For routine laboratory work to cutting edge research

From the simplest experiments to tomorrow's demanding applications, Varian probes consistently deliver superior performance required for confident and dependable analyses. We offer a broad selection of probes for liquids, solids and imaging to support a range of applications. Our engineered probes cover an array of sensitivities, radio frequencies, spinning technologies, resonance styles and field strengths to provide the highest performance for your laboratory.

Ordering Information

Nano probes

Description	Detection and Probes	Part No.
Nano Probe™ Sample Plug, Wide Mouth for 4 mm (40 µL) Tubes	$^1\text{H}\{^{15}\text{N}-^{31}\text{P}\}$ PFG indirect detection and $^{15}\text{N}-^{31}\text{P}\{^1\text{H}\}$ broadband Nano Probes	190952000
Nano Probe Sample Plug for 4 mm (40 µL) Tubes		99265502
Nano Probe Sample Tube, 4 mm (40 µL)		99259100
Sample Tube Assembly Kit, Wide Mouth, 4 mm, Five Zirconia™ Sample Tubes with Drive Rings, O-rings and Plugs. (Includes assembly tool and manual)	$^1\text{H}\{^{15}\text{N}-^{31}\text{P}\}$ PFG indirect detection and $^{15}\text{N}-^{31}\text{P}\{^1\text{H}\}$ broadband Nano Probes	191063200
Sample Tube Assembly Kit, Wide Mouth, 4 mm, Without Assembly Tool and Manual	$^1\text{H}\{^{15}\text{N}-^{31}\text{P}\}$ PFG indirect detection and $^{15}\text{N}-^{31}\text{P}\{^1\text{H}\}$ broadband Nano Probes	191138500
Nano Probe Sample Tube, Flanged, Wide Mouth	$^1\text{H}\{^{15}\text{N}-^{31}\text{P}\}$ PFG indirect detection and $^{15}\text{N}-^{31}\text{P}\{^1\text{H}\}$ broadband Nano Probes	190951800
Nano Probe Sample Tube Kit, Small Mouth. (Includes 4 mm sample plug, plug tool, glue-less drive ring, rotor glass extractor tool, black marker pen, 15 x 45 mm vial, sample alignment tool assembly, 4 mm sample tube, NMR sample carton)	$^1\text{H}\{^{15}\text{N}-^{31}\text{P}\}$ PFG indirect detection and $^{15}\text{N}-^{31}\text{P}\{^1\text{H}\}$ broadband Nano Probes	190595801

NMR Sample Tubes

High quality NMR sample tubes for liquid state applications.

Ordering Information

Solution sample tubes

Description	Part No.
Sample Tube, 10 mm (4/pk)	92495603
Precision Sample Tube (25/pk)	90537000

NMR Standard Solutions: Optimized for the Highest Possible Performance

- Made to exacting Varian specifications to ensure sample consistency
- Popular standard samples available to meet your solution needs
- Gives you confidence in your NMR results

Ordering Information

Standard solutions 5 mm

Description	Part No.
Line Shape 5% CHCl_3 in CDCl_3	96812099
Auto Test Sample, ^{13}C , ^{15}N	190185506
Applications Test, 2% 2-ethyl-1-indanone	190185503
^{13}C Sensitivity, ASTM, 40% dioxane in benzene- d_6	96812069
Indirect Detection, 1 1 HAZ, $^{13}\text{CH}_3\text{I}$ in CDCl_3	96812096
^1H sensitivity, 0.1% ethylbenzene, 0.01% TMS, CDCl_3	96812070

Solution State Sample Turbine: For Reliable Spin and Optimum Line Shape

- Compatible with a wide range of sample tube sizes for flexibility
- Robust turbine materials ensure product longevity
- Easy to fit

Ordering Information

Solution turbine

Description	Diameter (mm)	Part No.
Turbine	1.7	NL58006600
Turbine for Micro Probes	3	190182700
Turbine	5	94844701
Turbine (15/pk)	5	99749800
Turbine	10	94844601
Turbine (15/pk)	10	99749900
Turbine Heat Relief	4	190255400
O-ring	5	2740280300



Nuclear Magnetic Resonance

Rotors, Spin Modules and Starter Kits: Widest Range of Solid State NMR Probes

- Increased rotor length delivers exceptional spinning stability and coil design
- Separate VT gas supply increases sample VT range
- Scalable diameters from 2.5 mm to a true bucket of 14 mm

PENCIL™ rotor technology provides longer rotors that offer users performance advantages for the best possible results. Increased rotor length provides exceptional spinning stability and optimum coil design for frequency, homogeneity, and sample volume, and the separate VT gas supply for drive and bearing increases the sample VT range.

Ordering Information

Solid spin module - modules include the RF coil

Description	Diameter (mm)	Part No.
MAS Module, Vespel®, no Tachometer	2.5	MPRA000078
MAS Module, Vespel, no Tachometer	3.2	MPRA000079
MAS Module, Vespel, no Tachometer	4.0	MPRA000080
PENCIL Rotor MAS Module	7.5	MPRA000075

Solution rotors - seals solid state sample rotors for use with samples containing solvent

Description	Volume (µL)	Diameter (mm)	Part No.
Narrow Bore. (Includes one complete liquids rotor and requires packing tool kit MSPA000238)	46	4.0	MSPA000237

Liquids sample spacers have a specific spinning and VT range, which may be different than the probe. Contact your Varian representative to request further information about spinning and VT range specifications document, (M005003000).

Ordering Information

Solid rotor assembly

Description	One of each component included					Part No.
	Volume (µL)	Diameter (mm)	Top / Bottom Spacers	Rotor Sleeve	Drive Tip	
Narrow Bore, General Purpose	46	4.0				MSPA006048
Narrow Bore General Purpose	90	5.0				MSPA006051
Narrow Bore General Purpose	155	6.0				MSPA006054
General Purpose	11	2.5				MSPA003050
	22	3.2	included	included	included	MSPA003018
	52	4.0	Teflon®	Zirconia™	Vespel	MSPA003006
	160	5.0	Teflon	Zirconia	Vespel	MSPA003005
	450	7.5	Teflon	Zirconia	Kel-F™	MSPA003001
Heavy Sample	11	3.2	Teflon	Zirconia	Vespel	MSPA003015
Limited Speed	36	3.2	Torlon®	Zirconia	Torlon	MSPA015000
Thin Wall, Limited Speed	83	4.0	Teflon	Zirconia	Vespel	MSPA005062
Red 13C, Ceramic	105	5.0	Boron nitride	Zirconia	Vespel	MSPA003008
Red 13C, Ceramic	320	7.5	Boron nitride	Zirconia	Kel-F	MSPA003007
Reduced 19F	52	4.0	Vespel	Zirconia	Vespel	MPRA000060



Nuclear Magnetic Resonance

Solid Starter Kit

PENCIL™ MAS probe starter kits provide a convenient collection of parts and tools to get you up and running with a new MAS probe.

Liquid Starter Kit

Liquid starter kits provide you with a convenient collection of parts and tools to get you started when using a new MAS probe.

Ordering Information

Liquid starter kit

Description	Volume (μL)	Diameter (mm)	Part No.
Narrow and Wide Bore	22	3.2	MPRA000123
Narrow and Wide Bore	36	3.2	MPRA000126

Liquid sample spacers have a specific spinning and VT range, which may be different than the probe. Contact your Varian representative to request further information about spinning and VT range specifications document, (M005003000). Kit includes packing tools, five complete liquids rotor assemblies plus two extra sets of liquids sample spacers for spinning samples.

Ordering Information

Solid starter kits

Description	Volume (μL)	Diameter (mm)	Max Spin Rate Frequency (kHz)	Top and Bottom Spacers/Type	Rotor Sleeves	Drive Tips	Part No.
FastMAS™ Probe. (Includes seven complete rotors, end cap, packing/unpacking/rotor insertion and removal tools)				Included		Included	SG00Z00491
UltraFastMAS™ Probe. (Includes seven complete rotors, end cap, packing/unpacking/rotor insertion and removal tools)				Included		Included	SG00Z00492
General Purpose. (Includes drive tip wrenches, end cap extraction and sample packing tools)	11	2.5	30	11 of each/Vespel®	5/Zirconia	7/Vespel	MPRA000319
	22	3.2	18	11 of each/Vespel	5/Zirconia	7/Vespel	MPRA000043
	450	7.5		11 of each/Teflon®	5/Zirconia®	7/Kel-F™	MPRA000001
Heavy Sample, (For use when spinning high density materials; also useful for limited amounts of sample, includes drive tip wrenches, end cap extraction and sample packing tools)	11	3.2	25	11 of each/Vespel	5/Zirconia	7/Vespel	MPRA000318
Limited Speed, (For use where largers sample volume is required and limited speed acceptable, includes drive tip wrenches, end cap extraction and sample packing tools)	36	3.2	15	11 of each/Vespel	5/Zirconia	7/Vespel	MPRA000106
Narrow Bore, General Purpose. (Includes drive tip wrenches, end cap extraction and sample packing tools)	46	4.0	18				MPRA000504
	90	5.0	12	11 of each/Vespel	5/Zirconia	7/Vespel	MPRA000501
Red 13C, Ceramic. (Includes drive tip wrenches, end cap extraction and sample packing tools, nine Kel-F vented end caps)	320	7.5		9 of each/Boron nitride	5/Zirconia	7/Kel-F	MPRA000029
Wide Bore Starter Kit, General Purpose. (Includes drive tip wrenches, end cap extraction and sample packing tools)	52	4.0	18	11 of each/Teflon	5/Zirconia	7/Teflon	MPRA000007
Wide Bore, General Purpose. (Includes drive tip wrenches, end cap extraction and sample packing tools)	240	6.0		11 of each/Teflon	5/Zirconia	7/Vespel	MPRA000424
	160	5.0		11 of each/Teflon	5/Zirconia	7/Vespel	MPRA000002



Dissolution

Dissolution Paddles, Baskets and Shafts

- Serialized components improve identification for documentation and relocation
- Numerous length options provide customization to your specific apparatus
- Components are available in a variety of finishes to meet your testing requirements

Varian provides one- and two-piece paddle, basket and shaft assemblies that are manufactured to USP specifications. One-piece assemblies are designed for maintaining the same USP apparatus setup while the two-piece (interchangeable) assemblies allow you to easily switch between baskets and paddles, USP Apparatus 1 and 2, respectively, without readjusting the shaft height.

Ordering Information

Dissolution paddles, baskets and shafts

Description	Part No.
One-piece Teflon®-coated Paddle for use with V-Series™, 14.5 in.	12-1005
One-piece Teflon-coated Paddle, 15 in.	12-1000
One-piece Teflon-coated Paddle, 19 in.	12-1010
One-piece Teflon-coated Paddle, 24 in.	12-1015
One-piece Electropolished Paddle for use with V-Series, 14.5 in.	12-1030
One-piece Electropolished Paddle, 15 in.	12-1035
One-piece Electropolished Paddle, 19 in.	12-1040
One-piece Electropolished Paddle, 24 in.	12-1045
One-piece PEEK™ Paddle for Use with V-Series, 14.5 in.	12-1205
One-piece PEEK Paddle, 15 in.	12-1201
One-piece PEEK Paddle, 19 in.	12-1211
Interchangeable Paddle Shaft, 15 in., when Fully Assembled	12-1400
Interchangeable Paddle Shaft, 21 in., when Fully Assembled	12-1433
Interchangeable Paddle Shaft, 24 in., when Fully Assembled	12-1402
Interchangeable Paddle Assembly, Teflon-coated	12-1420
Interchangeable Paddle Assembly, Electropolished	12-1421
Interchangeable Paddle Assembly, PEEK	12-1440
One-piece Basket Shaft, USP Standard Head, 15 in. (baskets separate)	12-2070
One-piece Basket Shaft, USP Standard Head, 19 in. (baskets separate)	12-2080
One-piece Basket Shaft, USP Standard Head, 24 in. (baskets separate)	12-2095
One-piece Basket Shaft, USP Standard Head, for use with V-Series, 14.5 in. (baskets separate)	12-2073

Ordering Information

Dissolution paddles, baskets and shafts continued

Description	Part No.
Interchangeable Standard Basket Assembly with Clips, USP	12-1430
Interchangeable Standard Basket Assembly with O-ring	12-1431
Interchangeable Caliper/Zymark™ Type Basket Assembly, Conical	12-1432
Interchangeable Standard Basket Assembly with Clips for 2 L Vessel, USP	12-1438
Interchangeable Standard Basket Assembly with O-ring for 2 L Vessel	12-1439
Interchangeable Shaft, 15 in., when Fully Assembled	12-1400
Interchangeable Shaft, 19 in., when Fully Assembled	12-1401
Interchangeable Shaft, 21 in., when Fully Assembled	12-1433
Interchangeable Shaft, 24 in., when Fully Assembled	12-1402
Basket, USP, 40-mesh, Type 316 Stainless Steel, Standard	12-2100
Basket, USP, 40-mesh, Gold Plated	12-2105
Basket, 40-mesh, Teflon Coated, Type 316 Stainless Steel	12-2110
Basket, 40-mesh, Type 316 Stainless Steel, 3-fin Assembly	12-2115
Basket, 20-mesh, 864 µm Type 316 Stainless Steel	12-2120
Basket, 10-mesh, 1905 µm, Type 316 Stainless Steel	12-2125
Basket, Suppository, Slotted, Plastic	12-2130

Dissolution Vessels: For USP General Chapter 711

- Serialized vessels improve identification for documentation and relocation
- TruCenter™ vessels ensure centering consistency and eliminate misalignment
- PEEK™ vessels reduce hydrodynamic inconsistencies and prevent cone formation

Varian offers a complete line of dissolution vessels, all designed to meet specifications and recommended tolerances of the USP General Chapter 711, Dissolution. Available in 100 mL, 200 mL, 2 L and 4 L sizes, offering flexibility in accommodating a variety of testing requirements.

Ordering Information

Description	Part No.
Vessel, Clear Glass, 1000 mL	12-5000
Vessel, Amber Glass, 1000 mL	12-5010
TruCenter Vessel, Amber Glass, with Collar, 1000 mL	12-5120
PEEK Vessel, Clear Glass, 1000 mL	12-5500
Vessel, Clear Plastic, 1000 mL	12-5200



Dissolution

VK Verified Accessory Components

- Documents individually measured dimensions with matching unique serial numbers and meets requirements for Mechanical Qualification (MQ)
- Measurements of physical parameters taken using calibrated and traceable devices



Ordering Information

Verified accessory components

Description	Part No.
Interchangeable Shaft Assembly for V-Series™, 15 in.	12-1400V
Interchangeable Shaft Assembly, 19 in.	12-1401V
Interchangeable Shaft Assembly for 2 L Vessels, 24 in.	12-1402V
Interchangeable Paddle Assembly, Teflon®-coated	12-1420V
Interchangeable Paddle Assembly, Electropolished	12-1421V
Interchangeable Basket Assembly with Clips	12-1430V
Interchangeable Shaft Assembly for 1 L vessels, 21 in.	12-1433V
One-piece Teflon-coated Paddle, 15 in.	12-1000V
One-piece Teflon-coated Paddle for V-Series, 14.5 in.	12-1005V
One-piece Teflon-coated Paddle, 19 in.	12-1010V
One-piece Teflon-coated Paddle, 24 in.	12-1015V
One-piece Electropolished Paddle, 15 in.	12-1030V
One-piece Electropolished Paddle for V-Series, 14.5 in.	12-1035V
One-piece Electropolished Paddle, 19 in.	12-1040V
One-piece Electropolished Paddle, 24 in.	12-1045V
One-piece PEEK™ Paddle, 15 in.	12-1201V
One-piece PEEK Paddle, 19 in.	12-1211V
One-piece PEEK Paddle, 24 in.	12-1216V
One-piece Dura-Tef Shaft, 15 in.	12-1221V
Rotating Basket Assembly, 15 in. Shaft (40-mesh)	12-2000V
Basket Assembly, 19 in. Apparatus 1	12-2020V
Basket Assembly, 24 in. Apparatus 1	12-2025V
Basket Drive Shaft, USP, Teflon-coated, for V-Series	12-2041V
Basket Drive Shaft, USP, 15 in.	12-2070V
Basket Drive Shaft, USP, for V-Series	12-2073V
Basket Drive Shaft, USP, 19 in.	12-2080V

Ordering Information

Verified accessory components continued

Description	Part No.
Basket Drive Shaft, USP, 24 in.	12-2095V
Basket, 40-mesh, 381 µm	12-2100V
Basket, 20-mesh, 864 µm	12-2120V
Vessel, Clear Glass, 1000 mL	12-5000V
Vessel, Amber Glass, 1000 mL	12-5010V
Vessel, TruCenter™, Ground Centering Groove with Collar, 1000 mL	12-5035V
Vessel, DVH, Ground Centering Groove, 1000 mL	12-5039V
Vessel, TruCenter, Amber Glass, 1000 mL	12-5120V
Vessel, Clear Plastic, 1000 mL	12-5200V
Vessel, Clear Glass, 2 L	12-5070V
Vessel, Clear Glass, 4 L	12-5080V

Sampling Filters

- Provide immediate filtration to preserve the integrity of your dissolution sample
- Large filter surface ensures better sample flow
- Large surface area optimizes filter life

Because dissolution continues until the sample is filtered, Varian's Full Flow Filter™ offers you greater sample reliability. The filters are available in ultra-high molecular weight polyethylene (UHMWPE) or polyvinylidene fluoride (PVDF).

Tip

To view the Varian Dissolution Sourcebook and a range of other Dissolution literature, please visit www.varianinc.com/products/dissolution/sheets.html

Ordering Information

Description	Part No.
UHMWPE Filters, 10 µm, Blue, Pack of 100	17-4000
UHMWPE Filters, 35 µm, White, Pack of 100	17-4010
UHMWPE Filters, 70 µm, Red, Pack of 100	17-4020
PVDF Filters, 10 µm, Green, Pack of 100	17-4040
PVDF Filters, 35 µm, Yellow, Pack of 100	17-4050