

175 PSI WWP Iron Body Gate Valves

Fire Protection Valve • Bolted Bonnet • Outside Screw and Yoke • Solid Wedge •
Pre-Grooved Stem for Supervisory Switch Mounting



175 PSI/12.1 Bar Non-Shock Cold Water

CONFORMS TO MSS SP-70 •

UL/ULC LISTED* • FM APPROVED •

APPROVED BY THE NEW YORK CITY B.S.A. 143-69-SA

MATERIAL LIST

PART	SPECIFICATION
1. Stem	Copper Alloy, ASTM B16 C36000
2. Nut, Handwheel	Cast Copper Alloy, ASTM B584 C84400
3. Handwheel, Orange	Cast Iron, ASTM A126-B
4. Bushing, Yoke	Cast Copper Alloy, ASTM B584 C84400
5. Screw, Hex - Bonnet Cap	Steel, ASTM A307 / SAE J429
6. Cap, Bonnet	Ductile Iron ASTM A536
7. Nut, Square - Bonnet Cap	Steel, ASTM A563
8. Bonnet ¹	Cast Iron, ASTM A126-B
9. Nut, Heavy Hex - Gld Follow	Steel, ASTM A563
10. Gland Follower	Ductile Iron ASTM A536
11. Pack Gland	Powdered Metal ASTM B783
12. Pack Ring	Aramid Fiber / Graphite
13. Bolt, Sq Head - Gld Follow	Steel, ASTM A307 / SAE J429
14. Screw, Hex - Body	Steel, ASTM A307 / SAE J429
15. Gasket, Body	Synthetic Fiber / Nitrile
16. Nut, Hex - Body	Steel, ASTM A563
17. Collar, Stem	Copper Alloy, ASTM B16 C36000
18. Pin, Wedge	Copper Alloy, ASTM B140 C31600
19. Ring, Seat - Wedge	Cast Copper Alloy, ASTM B584 C84400
20. Wedge ²	Cast Iron, ASTM A126-B
21. Ring, Seat - Body	Cast Copper Alloy, ASTM B584 C84400
22. Body	Cast Iron, ASTM A126-B

¹ Sizes thru 8", Yoke and Bonnet are intergral. 10" and 12" sizes separate Yoke is bolted to Bonnet.

² Sizes 2½" thru 6" have Cast Copper Alloy Wedges.

Sizes 8" thru 12" made with Cast Iron Wedge with Cast Copper Alloy Face Rings.

TS: Pre-grooved Stem for Supervisory Switch Activation.

NOTE: 1. Valve Flanges per ASME B16.1, Class 125

2. NIBCO may substitute Ductile Iron ASTM A395 (60-40-18) for ASTM A126 Class B Cast Iron for the Body, Bonnet, Wedge, or Disc. NIBCO may substitute Ductile Iron ASTM A395 (60-40-18) or ASTM A536 (65-45-12) for all other ASTM A126 Class B Cast Iron components.

* Compliance with the Standard for Gate Valves for Fire Protection Service, UL 262, and the Canadian Requirements.

DIMENSIONS—WEIGHTS—QUANTITIES

Size	Dimensions										Weight		
	A		B		C		D		E		Lbs.	Kg.	
In. mm.	In.	mm.	In.	mm.	In.	mm.	In.	mm.	In.	mm.			
2½	65	7.50	191	17.26	438	8.00	203	7.00	178	0.69	18	55	25
3	80	8.00	203	19.44	494	8.00	203	4.50	114	0.75	19	67	30
4	100	9.00	229	23.54	598	10.25	260	9.00	229	0.94	24	107	49
5	125	10.00	254	27.01	686	10.25	260	10.00	254	0.94	24	145	66
6	150	10.50	267	30.73	781	12.00	305	11.00	279	1.00	25	178	81
8	200	11.50	292	40.29	1023	14.00	356	13.50	343	1.12	28	309	140
10	250	13.00	330	48.45	1231	16.25	413	16.00	406	1.19	30	481	219
12	300	14.00	356	56.26	1429	18.00	457	19.00	483	1.25	32	706	321

WARNING: This product can expose you to chemicals including lead, which is known to the State of California to cause cancer and birth defects or other reproductive harm. For more information go to www.P65Warnings.ca.gov.



F-607-OTS

Flanged

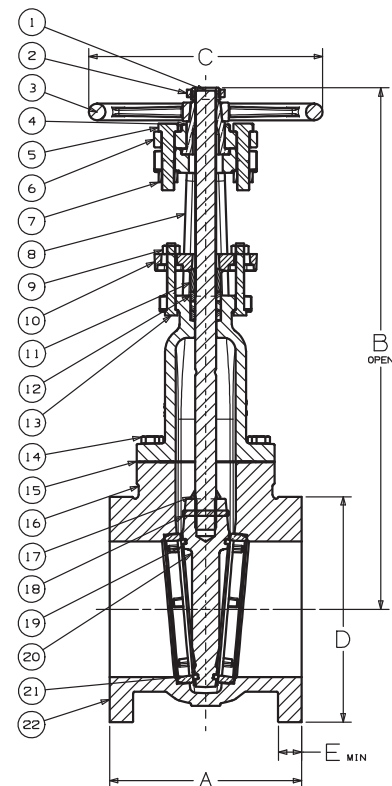

F-607-OTS

Flg x Flg

FREEZING WEATHER PRECAUTION: Subsequent to testing a piping system, gate valve should be in an open position to allow complete drainage.

Visit our website for the most current information.